

113 Sandhaugen Astrid Marie

Steinkjer Skiklubb

Result: 4

Shooting 1 - Prone at lane 1

5 shots at 16.4s Result: 2

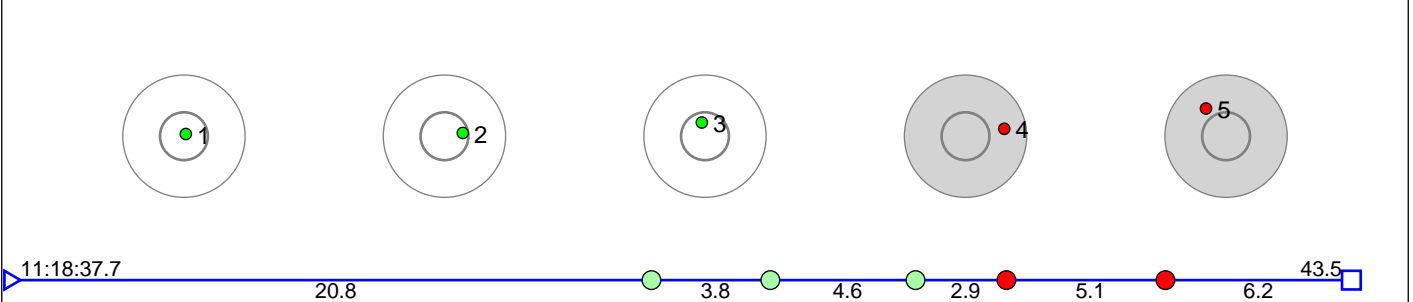

Shooting 2 - Standing at lane 9

5 shots at 18.2s Result: 2

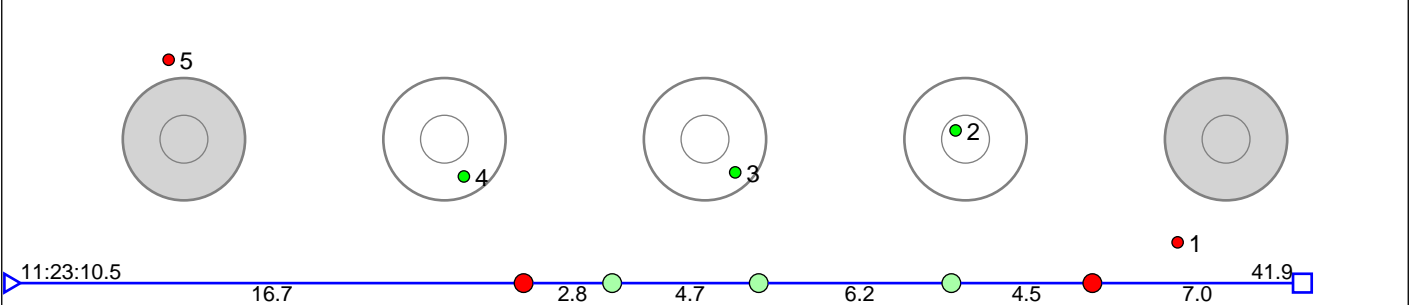

Disclaimer:

These results are unofficial since only the final output from the timing system can provide complete and correct competition results. The graphic plot of each series, presents the location of the shots on each of the five targets. Please observe that the accuracy of the plotting has some limitations due to image resolution and/or printer quality.

114 Bekkelund Selma

Østre Toten Skilag

Result: 7

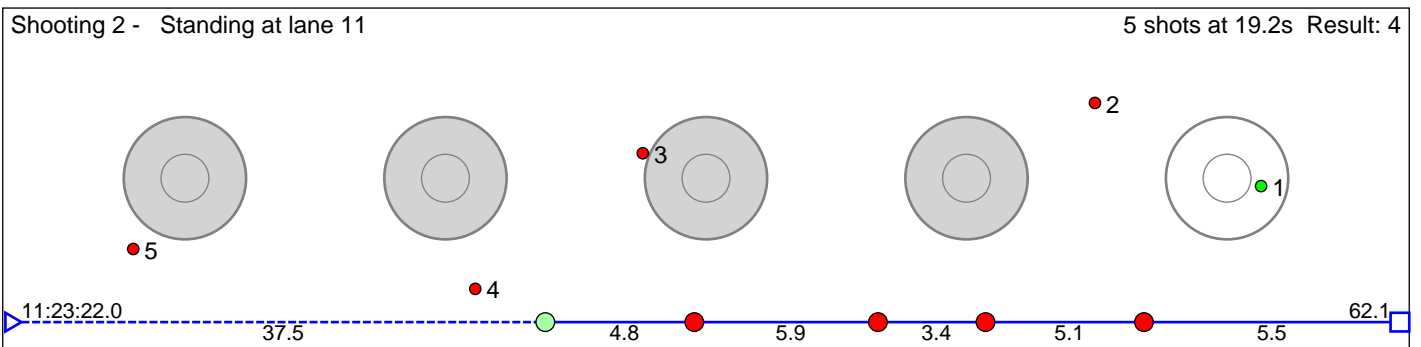
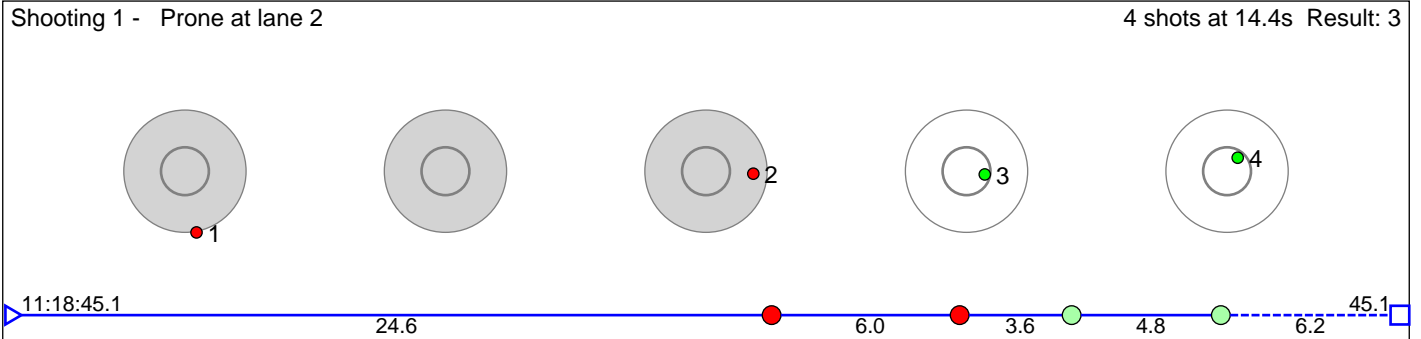

Disclaimer:

These results are unofficial since only the final output from the timing system can provide complete and correct competition results. The graphic plot of each series, presents the location of the shots on each of the five targets. Please observe that the accuracy of the plotting has some limitations due to image resolution and/or printer quality.

118 Alfstadsæther Andrea

Østre Toten Skilag

Result: 6

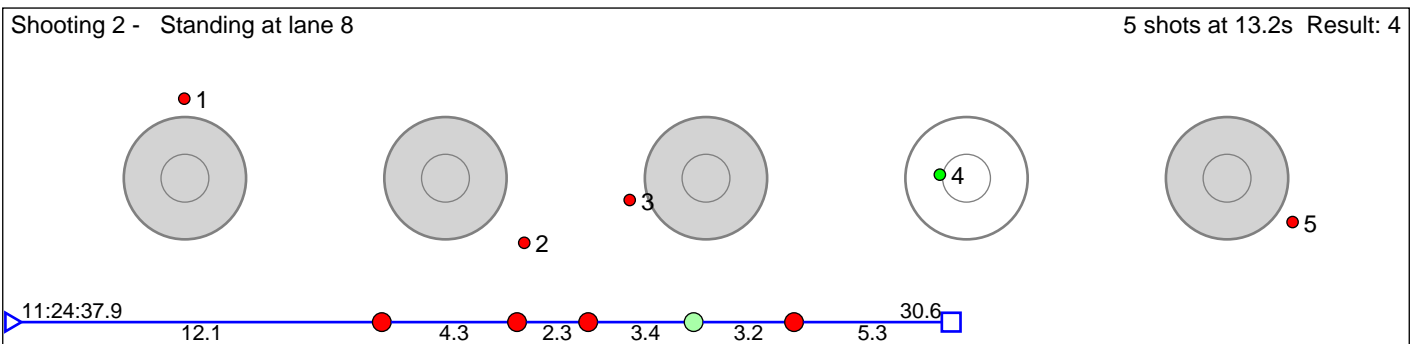
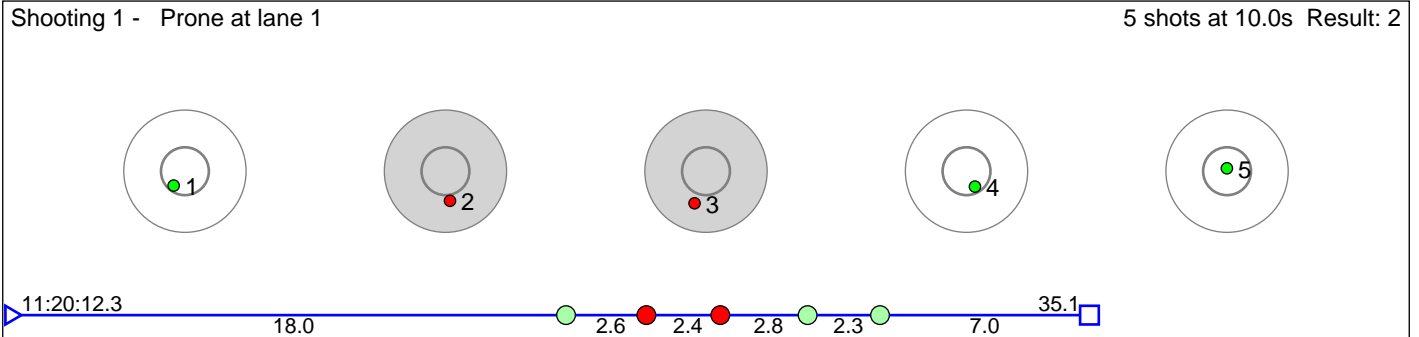

Disclaimer:

These results are unofficial since only the final output from the timing system can provide complete and correct competition results. The graphic plot of each series, presents the location of the shots on each of the five targets. Please observe that the accuracy of the plotting has some limitations due to image resolution and/or printer quality.

120 Ramsem Thyra

Rennebu IL

Result: 4

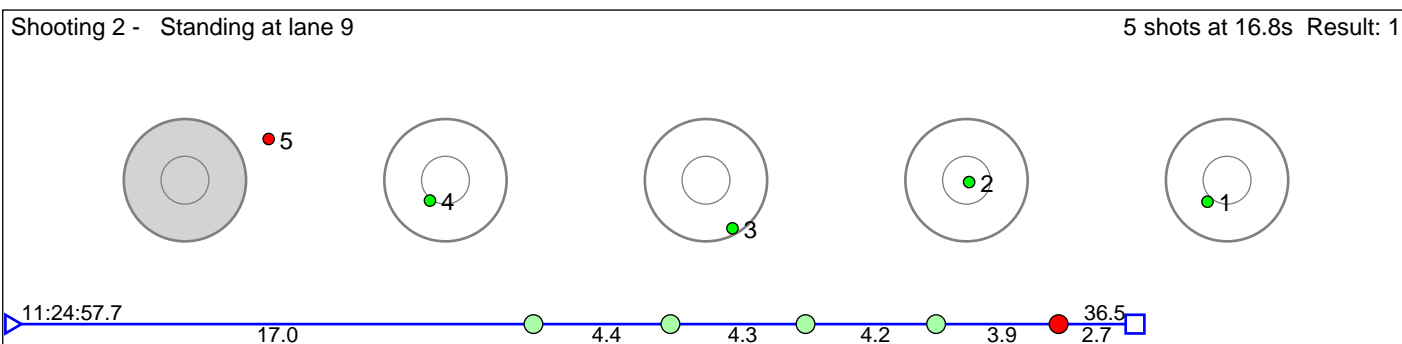
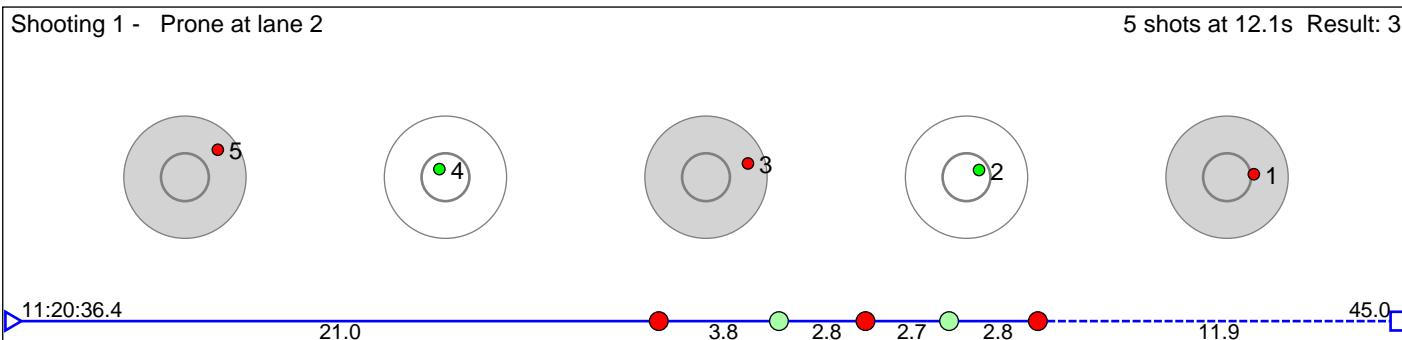

Disclaimer:

These results are unofficial since only the final output from the timing system can provide complete and correct competition results. The graphic plot of each series, presents the location of the shots on each of the five targets. Please observe that the accuracy of the plotting has some limitations due to image resolution and/or printer quality.

121 Hægeland Martha

Øvrebø IL

Result: 5

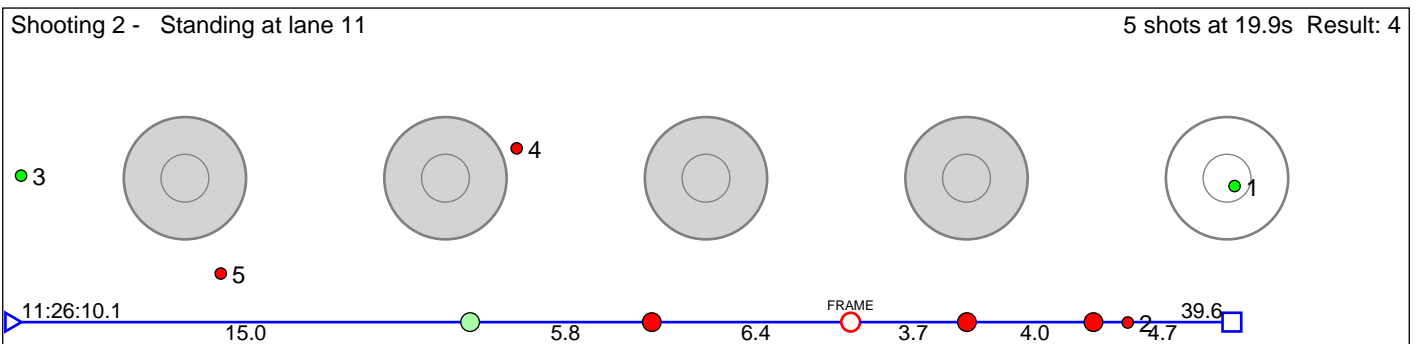
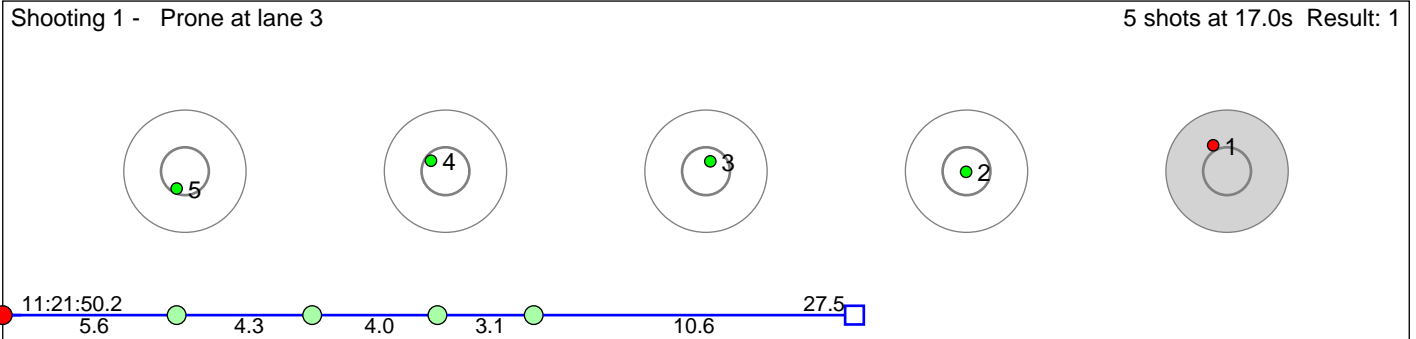

Disclaimer:

These results are unofficial since only the final output from the timing system can provide complete and correct competition results. The graphic plot of each series, presents the location of the shots on each of the five targets. Please observe that the accuracy of the plotting has some limitations due to image resolution and/or printer quality.

122 Bøylestad Marte

Froland IL

Result: 5

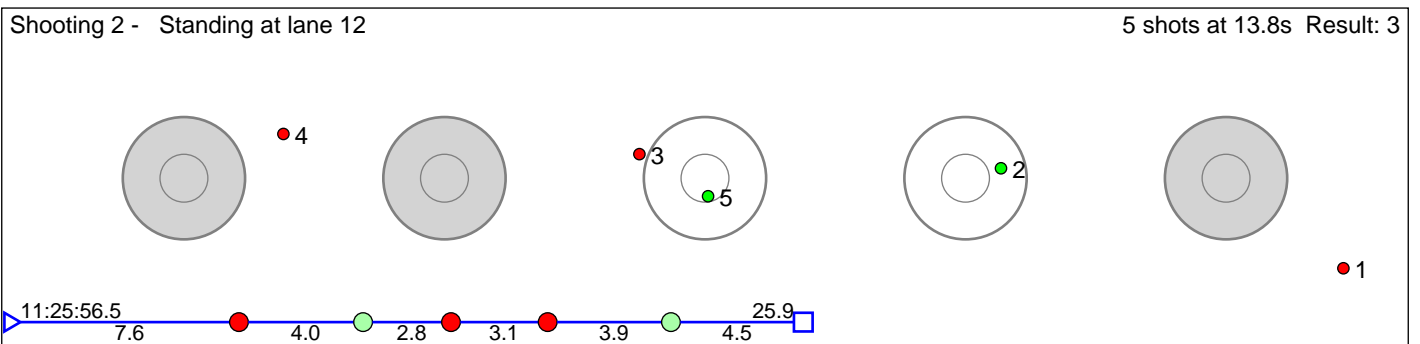
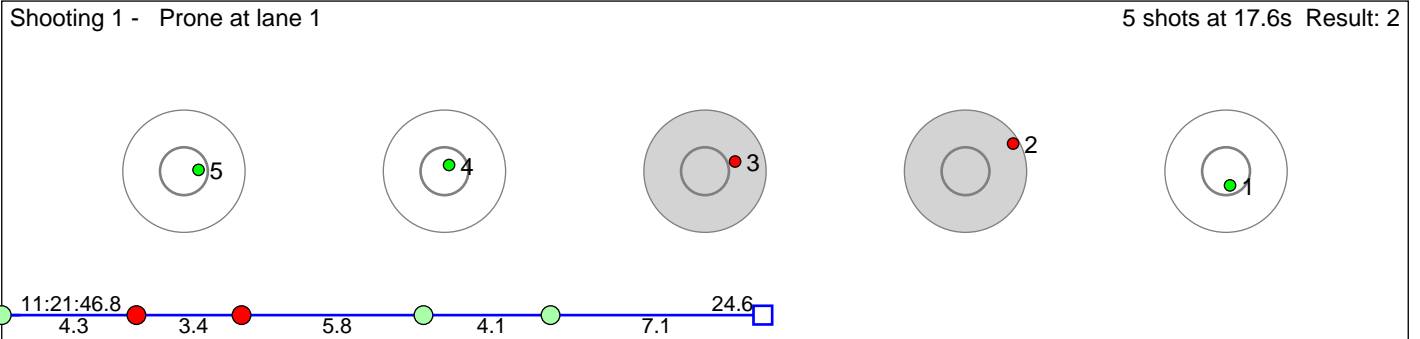

Disclaimer:

These results are unofficial since only the final output from the timing system can provide complete and correct competition results. The graphic plot of each series, presents the location of the shots on each of the five targets. Please observe that the accuracy of the plotting has some limitations due to image resolution and/or printer quality.

123 Samseth Antonia Mia

Bærums Skiklub

Result: 5

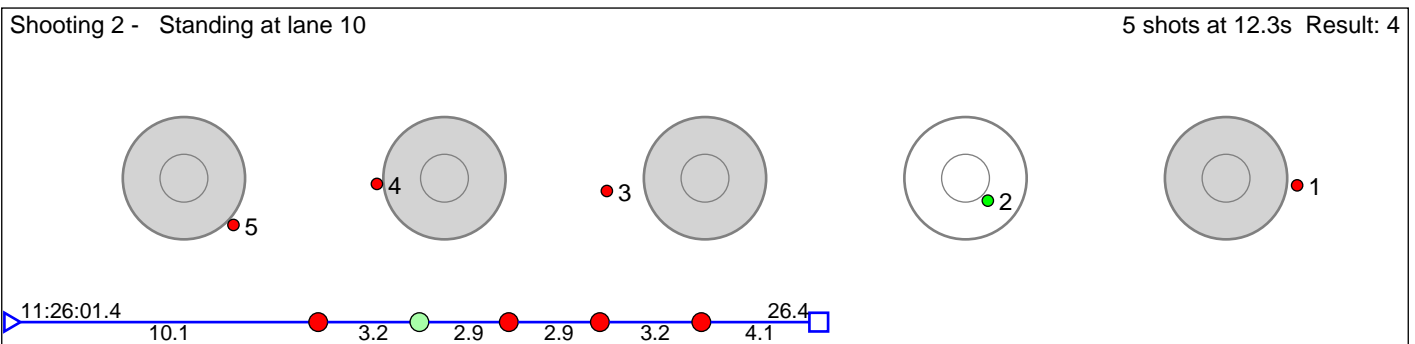
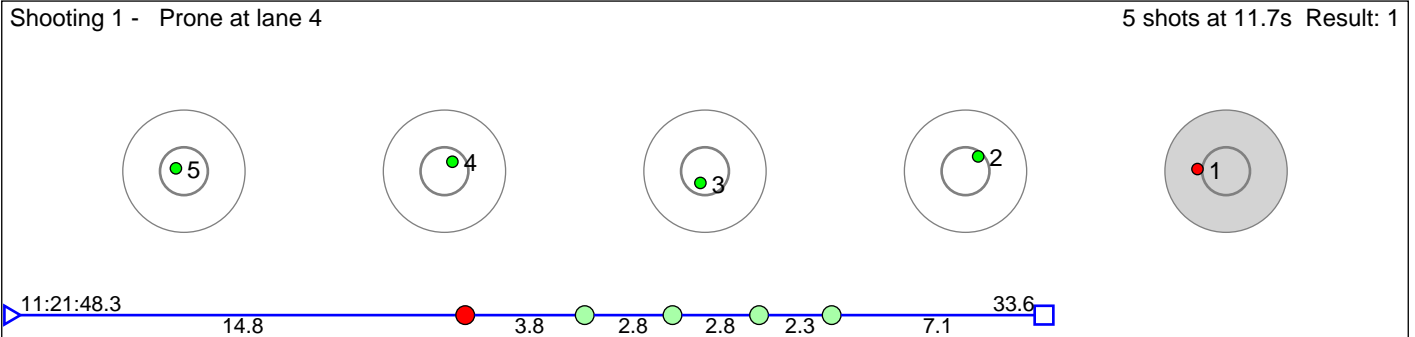

Disclaimer:

These results are unofficial since only the final output from the timing system can provide complete and correct competition results. The graphic plot of each series, presents the location of the shots on each of the five targets. Please observe that the accuracy of the plotting has some limitations due to image resolution and/or printer quality.

124 Hårstad Stine

Rennebu IL

Result: 7

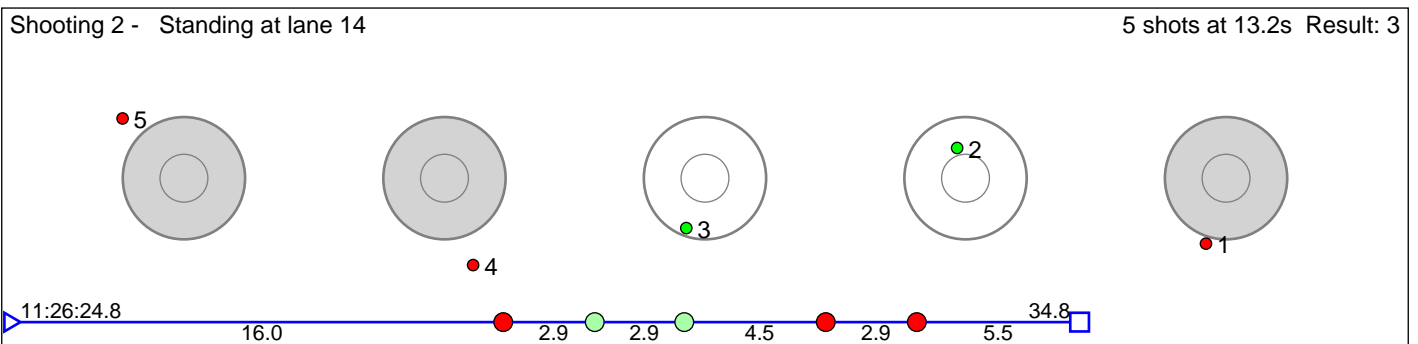
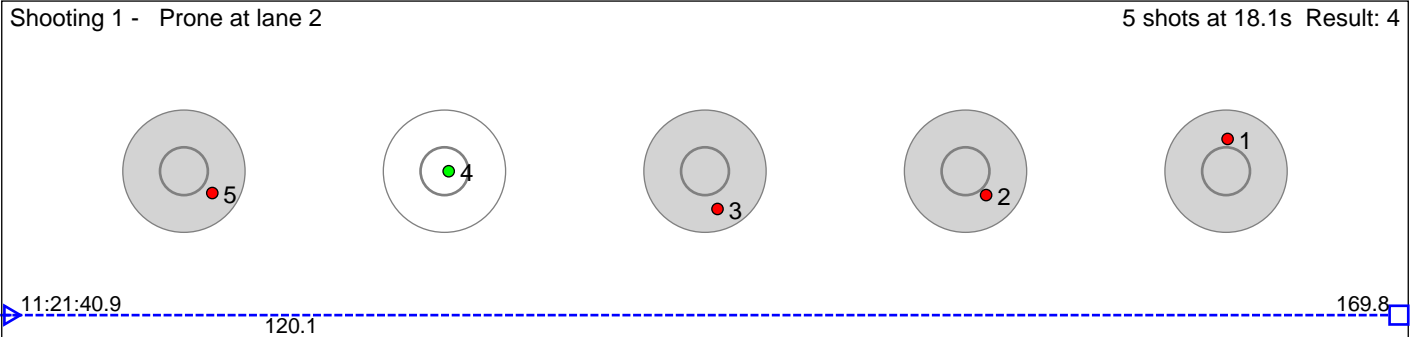

Disclaimer:

These results are unofficial since only the final output from the timing system can provide complete and correct competition results. The graphic plot of each series, presents the location of the shots on each of the five targets. Please observe that the accuracy of the plotting has some limitations due to image resolution and/or printer quality.

125 Eikemo Oline Christin

Sirdal Skilag

Result: 5

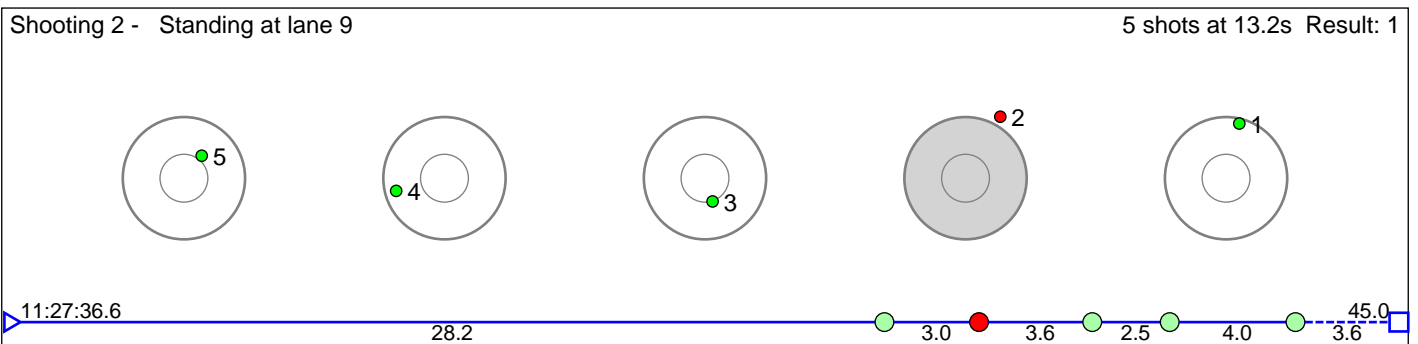
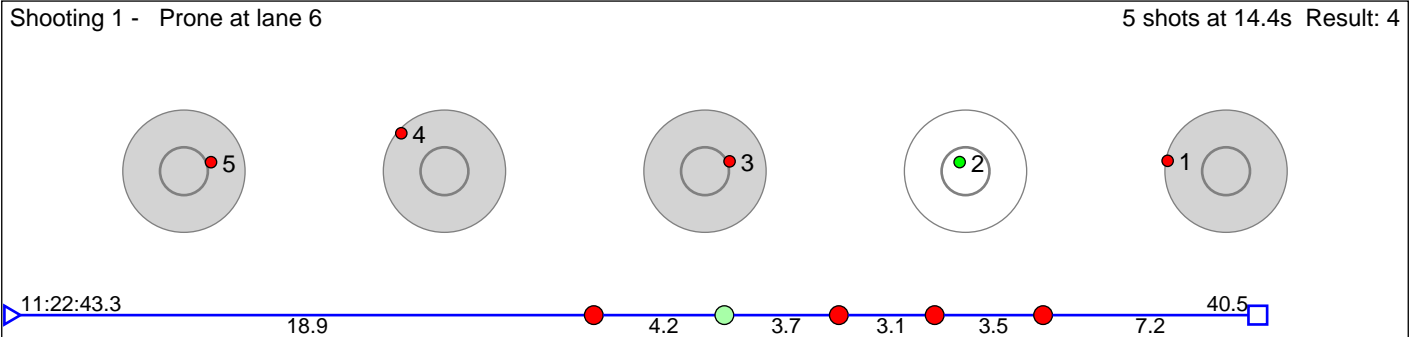

Disclaimer:

These results are unofficial since only the final output from the timing system can provide complete and correct competition results. The graphic plot of each series, presents the location of the shots on each of the five targets. Please observe that the accuracy of the plotting has some limitations due to image resolution and/or printer quality.

126 Halvorsen Sindre

Froland IL

Result: 9

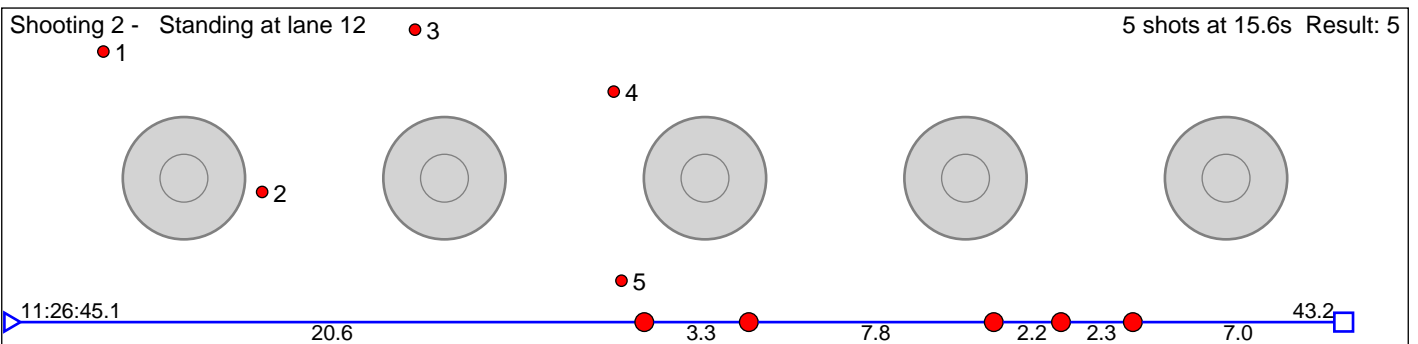
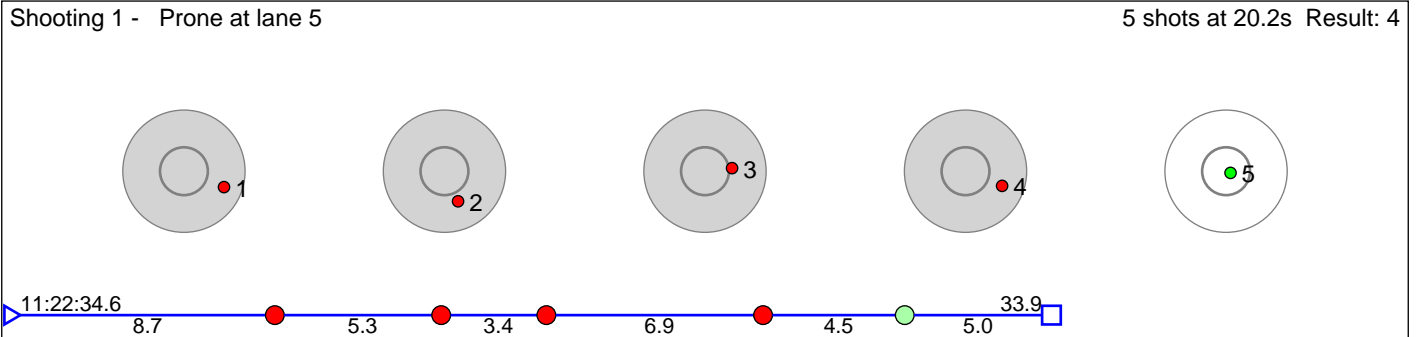

Disclaimer:

These results are unofficial since only the final output from the timing system can provide complete and correct competition results. The graphic plot of each series, presents the location of the shots on each of the five targets. Please observe that the accuracy of the plotting has some limitations due to image resolution and/or printer quality.

127 Fjærbu Torjus Fidje

Froland IL

Result: 5

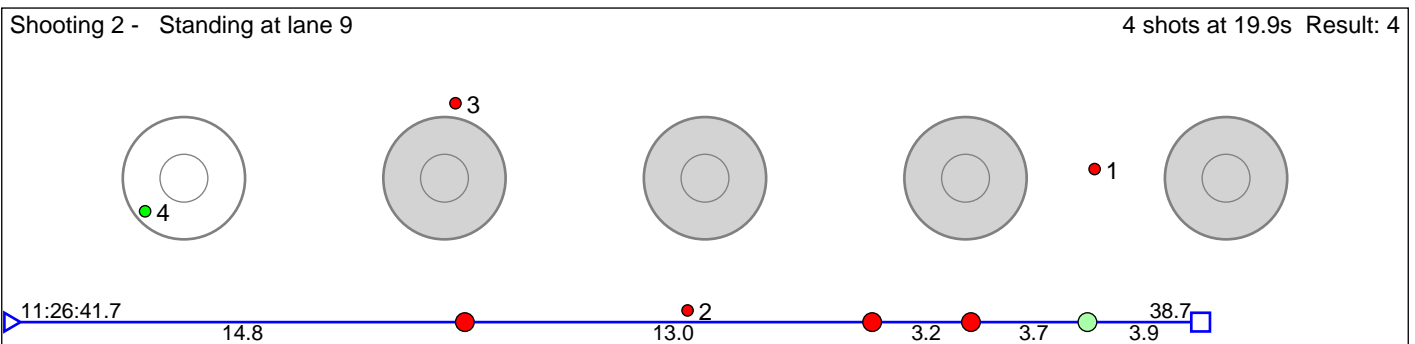
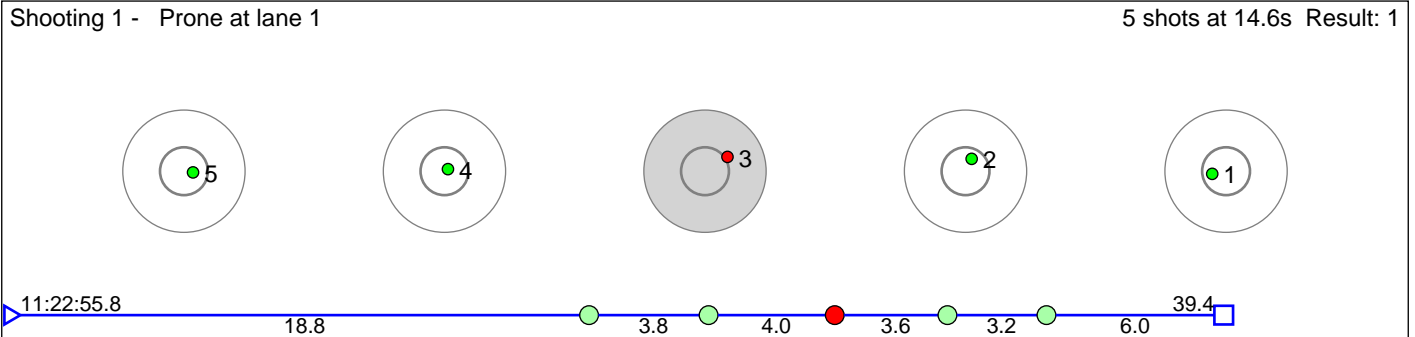

Disclaimer:

These results are unofficial since only the final output from the timing system can provide complete and correct competition results. The graphic plot of each series, presents the location of the shots on each of the five targets. Please observe that the accuracy of the plotting has some limitations due to image resolution and/or printer quality.

128 Husebø August Kirkeby

Oslo Skiskytterlag

Result: 5

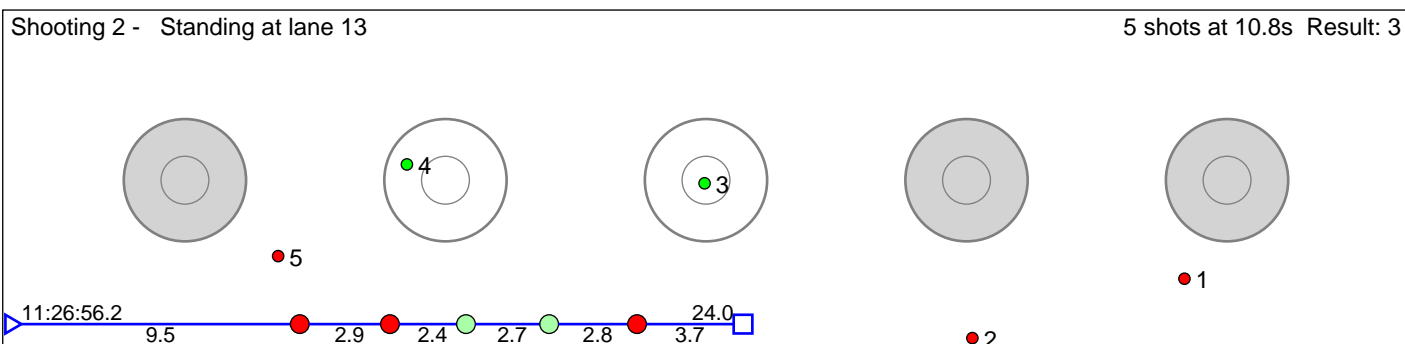
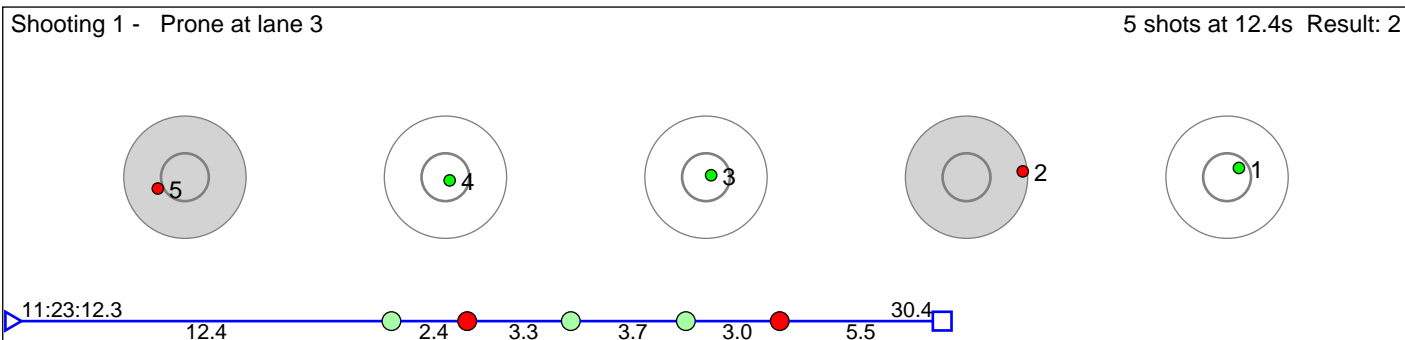

Disclaimer:

These results are unofficial since only the final output from the timing system can provide complete and correct competition results. The graphic plot of each series, presents the location of the shots on each of the five targets. Please observe that the accuracy of the plotting has some limitations due to image resolution and/or printer quality.

129 Hekneby Ulrik

Oslo Skiskytterlag

Result: 9

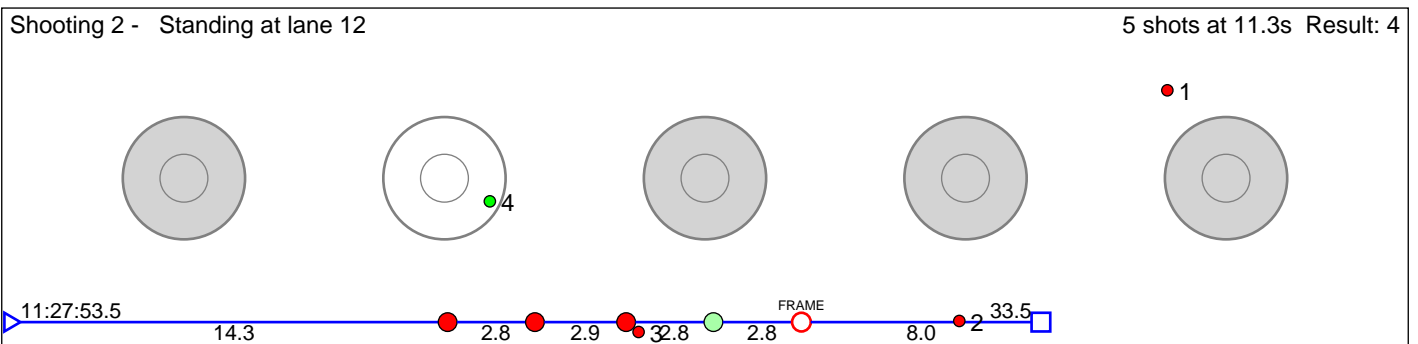
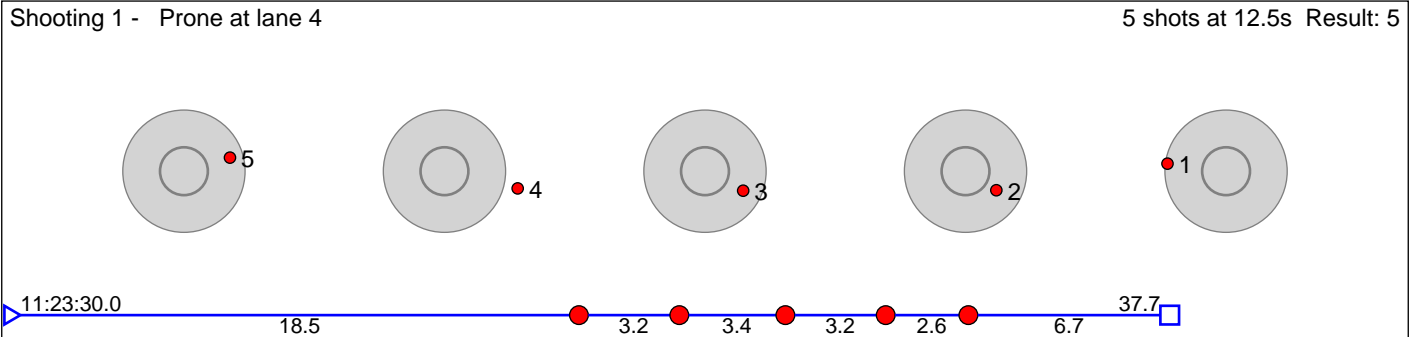

Disclaimer:

These results are unofficial since only the final output from the timing system can provide complete and correct competition results. The graphic plot of each series, presents the location of the shots on each of the five targets. Please observe that the accuracy of the plotting has some limitations due to image resolution and/or printer quality.

130 Torkildsen Thomas

Birkenes IL

Result: 6

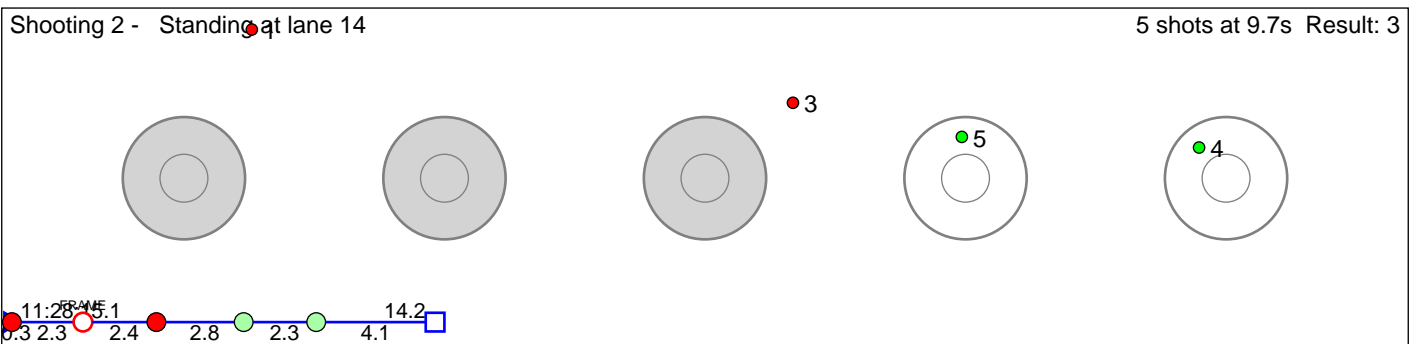
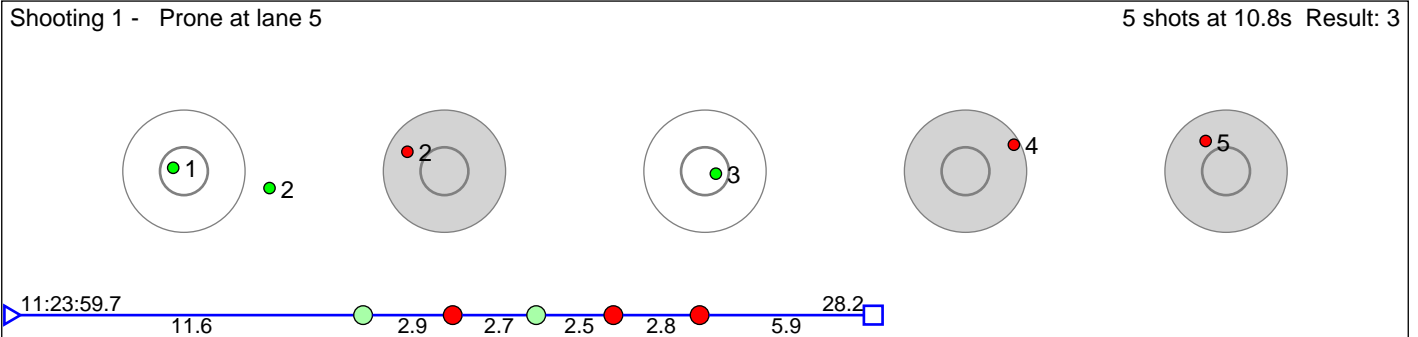

Disclaimer:

These results are unofficial since only the final output from the timing system can provide complete and correct competition results. The graphic plot of each series, presents the location of the shots on each of the five targets. Please observe that the accuracy of the plotting has some limitations due to image resolution and/or printer quality.

131 Frey Sondre Leknes

Bærums Skiklub

Result: 8

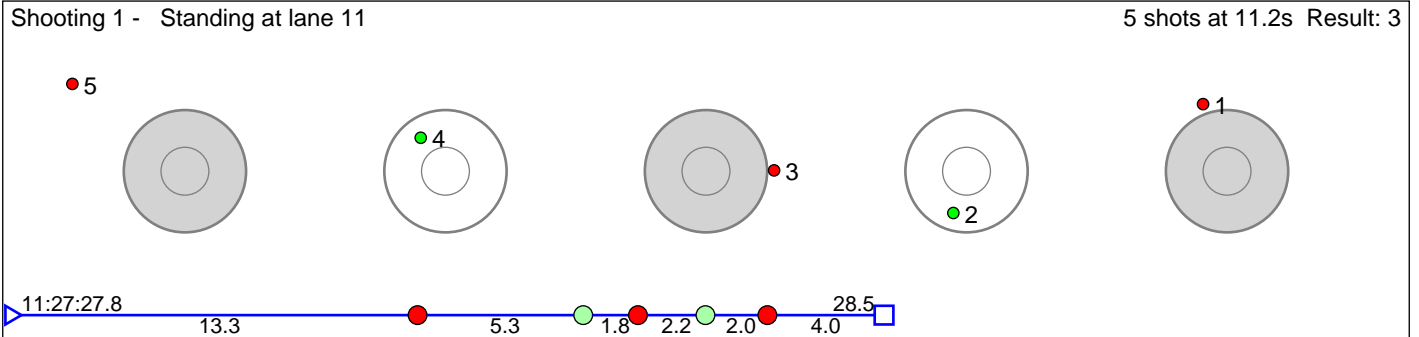

Disclaimer:

These results are unofficial since only the final output from the timing system can provide complete and correct competition results. The graphic plot of each series, presents the location of the shots on each of the five targets. Please observe that the accuracy of the plotting has some limitations due to image resolution and/or printer quality.

132 Sletvold Tobias

Figgjo IL

Result: 6

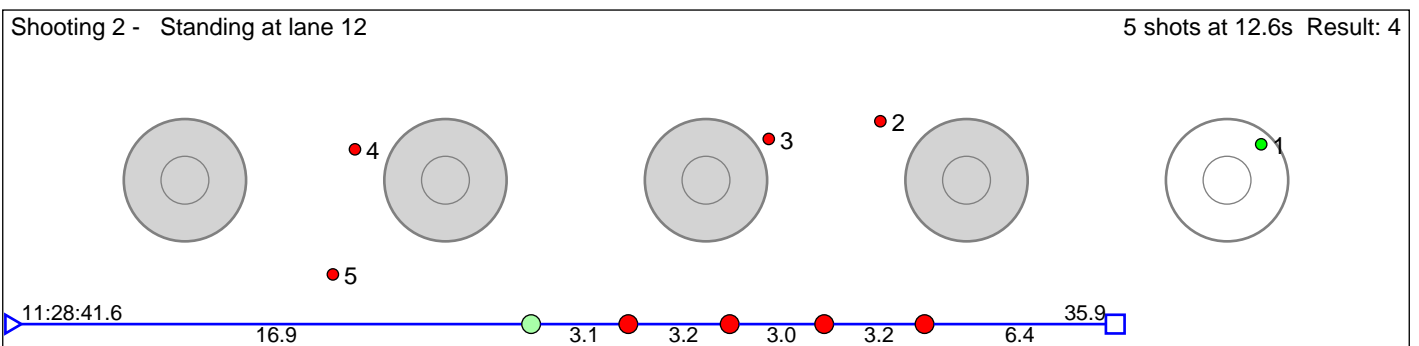
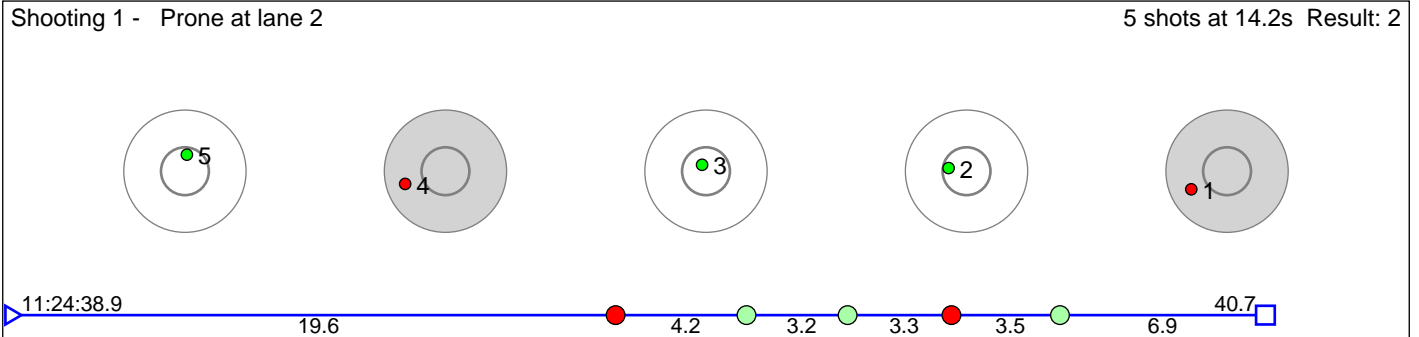

Disclaimer:

These results are unofficial since only the final output from the timing system can provide complete and correct competition results. The graphic plot of each series, presents the location of the shots on each of the five targets. Please observe that the accuracy of the plotting has some limitations due to image resolution and/or printer quality.

133 Wassbakk Magnus

Tromsø Skiskytterlag

Result: 3

Shooting 1 - Prone at lane 1

5 shots at 10.3s Result: 0

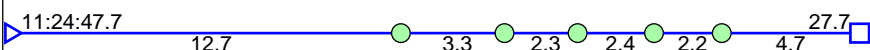
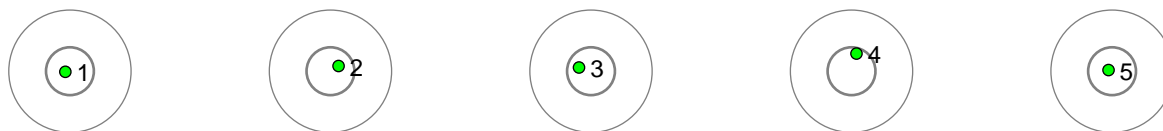

Shooting 2 - Standing at lane 13

5 shots at 16.8s Result: 3

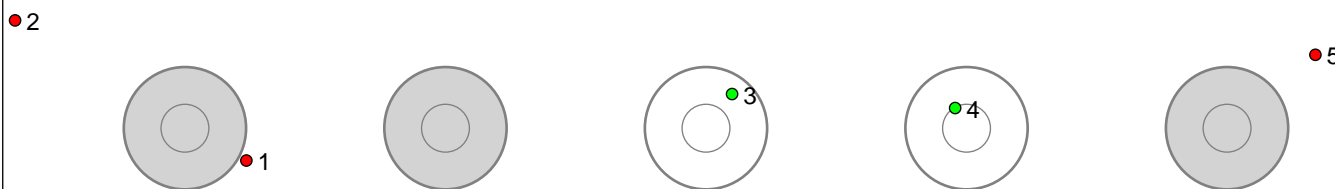

Disclaimer:

These results are unofficial since only the final output from the timing system can provide complete and correct competition results. The graphic plot of each series, presents the location of the shots on each of the five targets. Please observe that the accuracy of the plotting has some limitations due to image resolution and/or printer quality.

134 Thornquist Thorben Grytnes

Ivrig IL

Result: 7

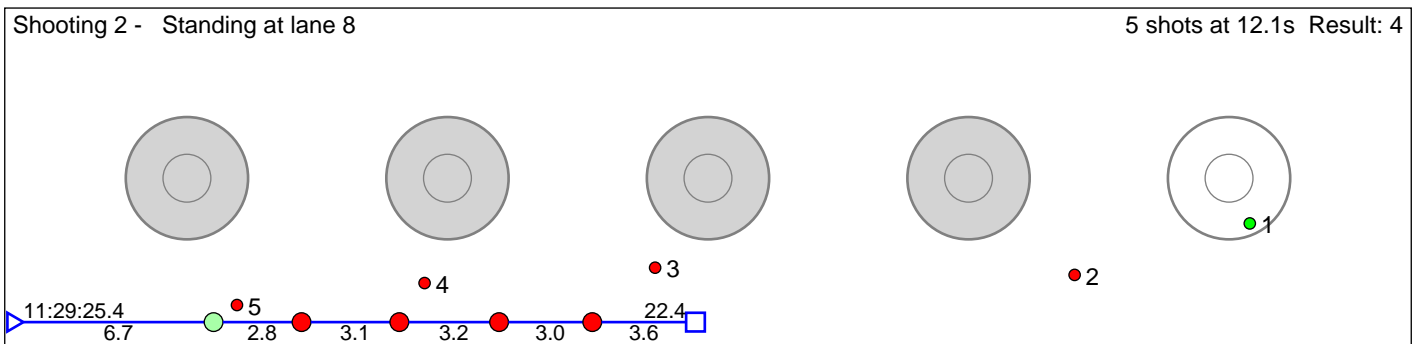
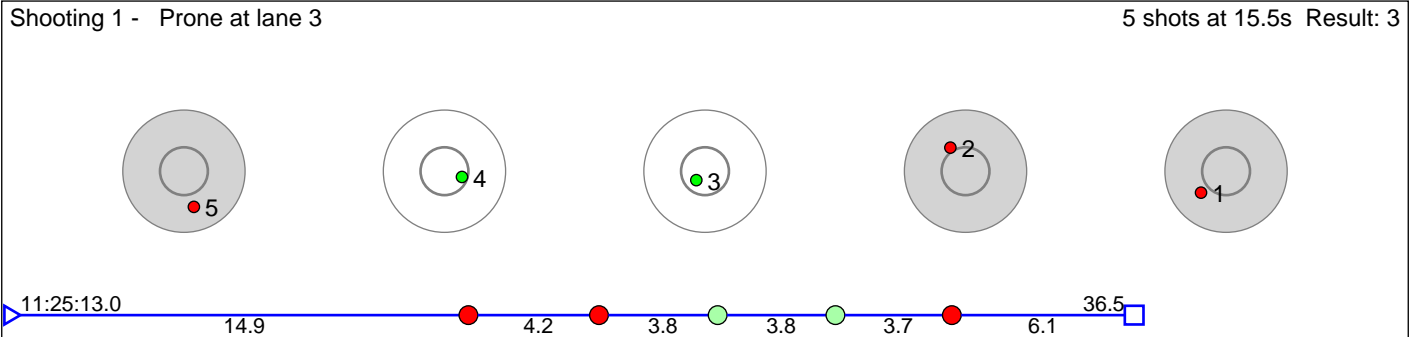

Disclaimer:

These results are unofficial since only the final output from the timing system can provide complete and correct competition results. The graphic plot of each series, presents the location of the shots on each of the five targets. Please observe that the accuracy of the plotting has some limitations due to image resolution and/or printer quality.

136 Aanesen Tobias Haugeglass

Birkenes IL

Result: 6

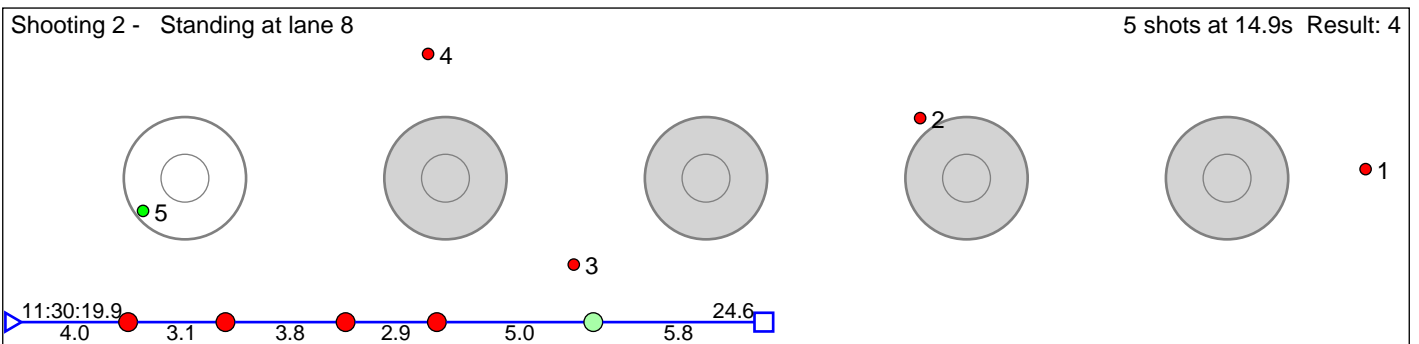
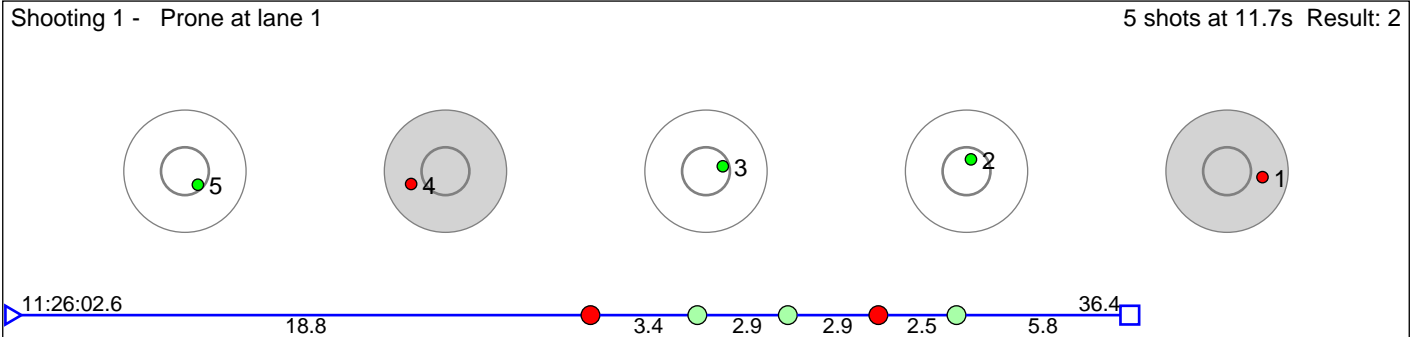

Disclaimer:

These results are unofficial since only the final output from the timing system can provide complete and correct competition results. The graphic plot of each series, presents the location of the shots on each of the five targets. Please observe that the accuracy of the plotting has some limitations due to image resolution and/or printer quality.

137 Stakkeland Martin Vatland

Kvinesdal ski- og skiskytterlag

Result: 7

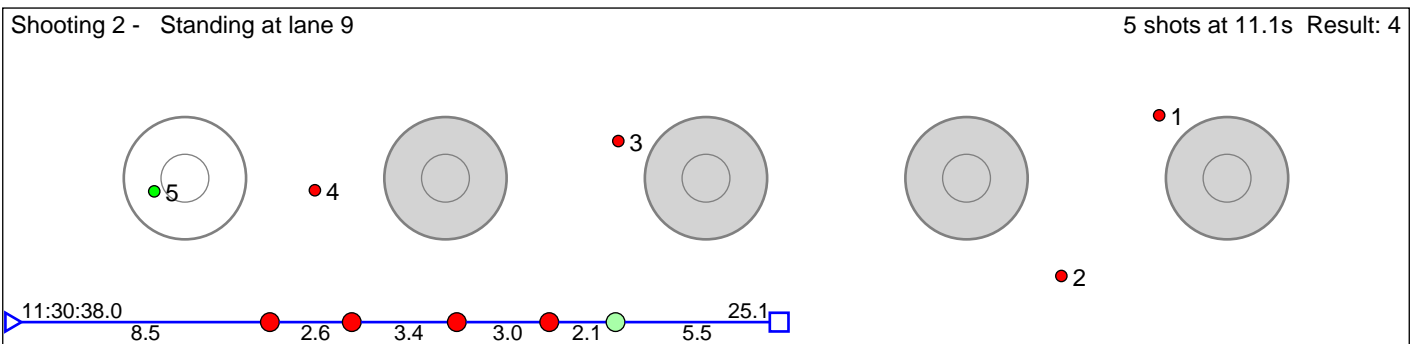
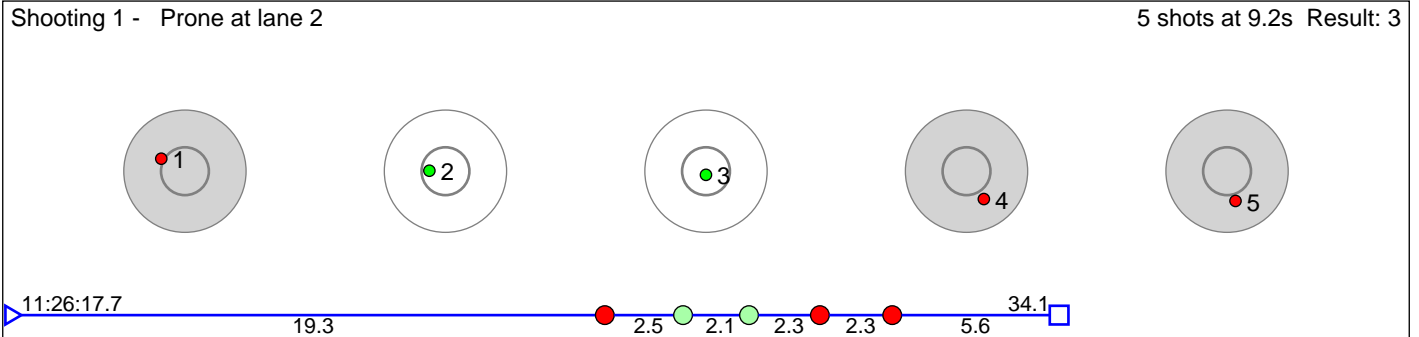

Disclaimer:

These results are unofficial since only the final output from the timing system can provide complete and correct competition results. The graphic plot of each series, presents the location of the shots on each of the five targets. Please observe that the accuracy of the plotting has some limitations due to image resolution and/or printer quality.

138 Smeland Johan

Birkenes IL

Result: 7

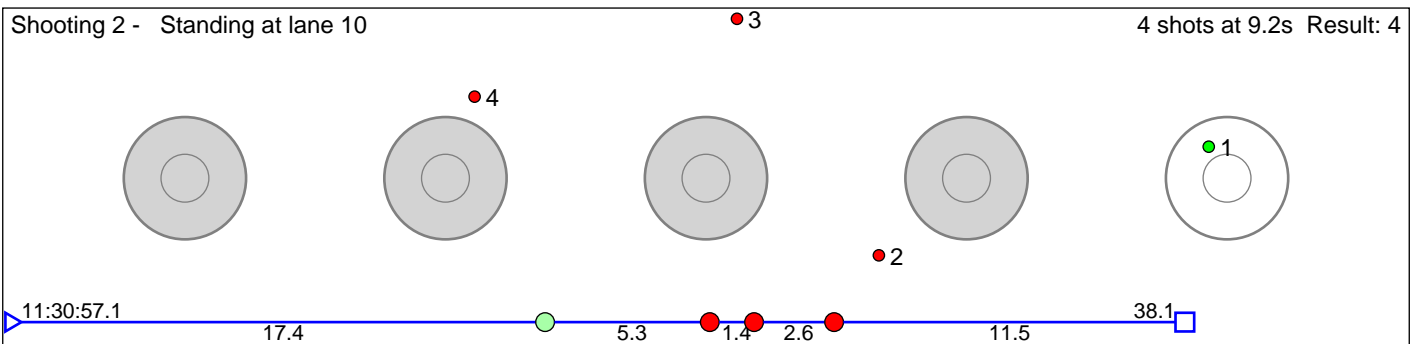
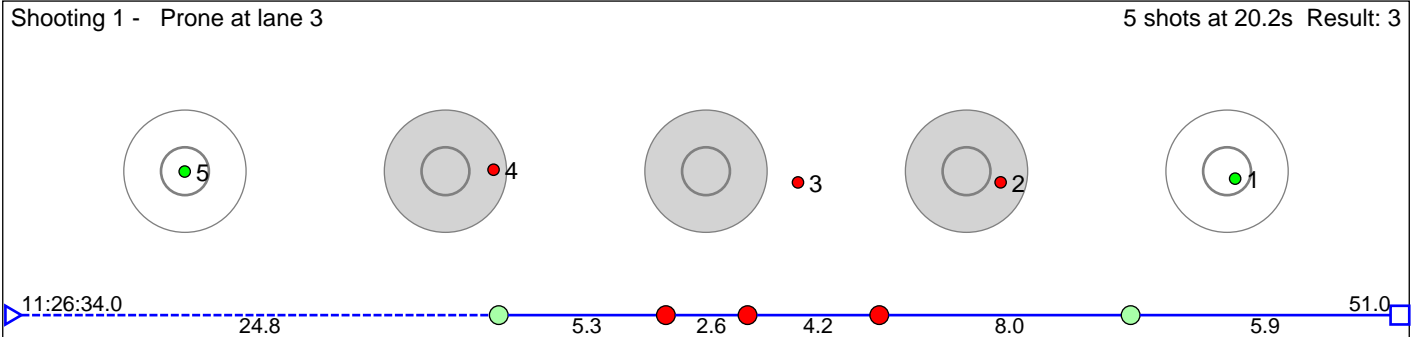

Disclaimer:

These results are unofficial since only the final output from the timing system can provide complete and correct competition results. The graphic plot of each series, presents the location of the shots on each of the five targets. Please observe that the accuracy of the plotting has some limitations due to image resolution and/or printer quality.

139 Mo Hedda Høen

Kvam Langrenn- og Skiskyttarklubb

Result: 6

Shooting 1 - Prone at lane 6 5 shots at 18.2s Result: 2

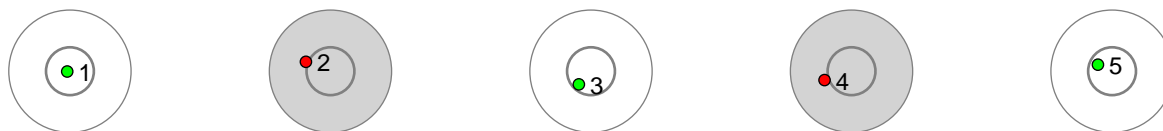

Shooting 2 - Standing at lane 12 5 shots at 19.0s Result: 4

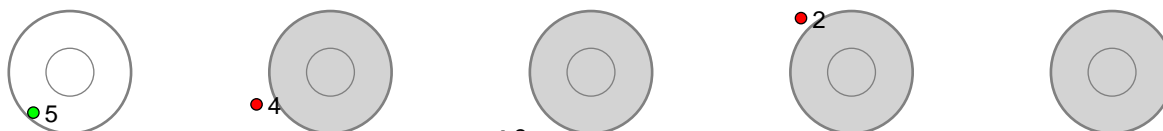

Disclaimer:

These results are unofficial since only the final output from the timing system can provide complete and correct competition results. The graphic plot of each series, presents the location of the shots on each of the five targets. Please observe that the accuracy of the plotting has some limitations due to image resolution and/or printer quality.

140 Andersson Ida Weber

Fossum IF

Result: 6

Shooting 1 - Prone at lane 7 5 shots at 10.6s Result: 2

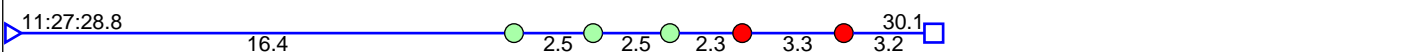
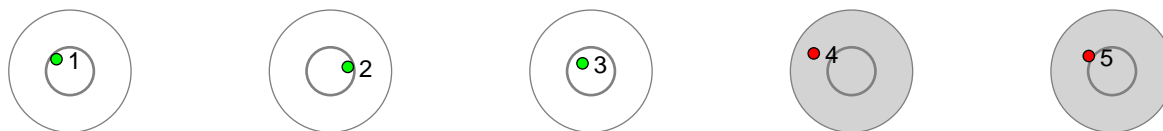

Shooting 2 - Standing at lane 11 5 shots at 26.1s Result: 4

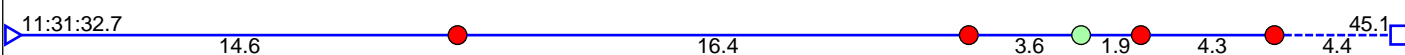
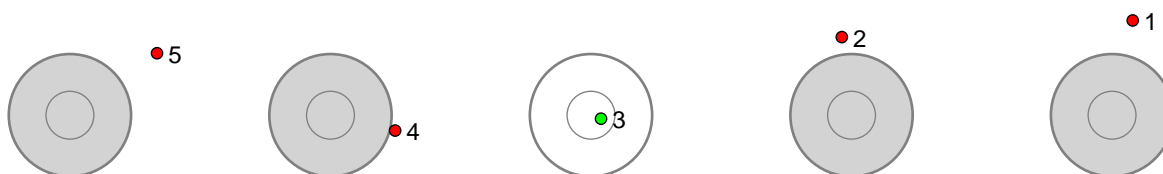

Disclaimer:

These results are unofficial since only the final output from the timing system can provide complete and correct competition results. The graphic plot of each series, presents the location of the shots on each of the five targets. Please observe that the accuracy of the plotting has some limitations due to image resolution and/or printer quality.

141 Tangen Eirin

Tynset IF

Result: 3

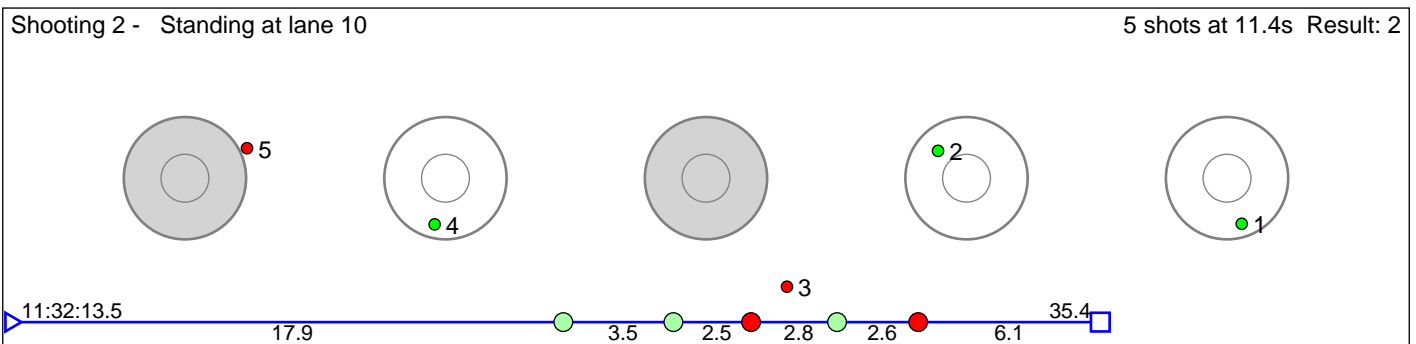
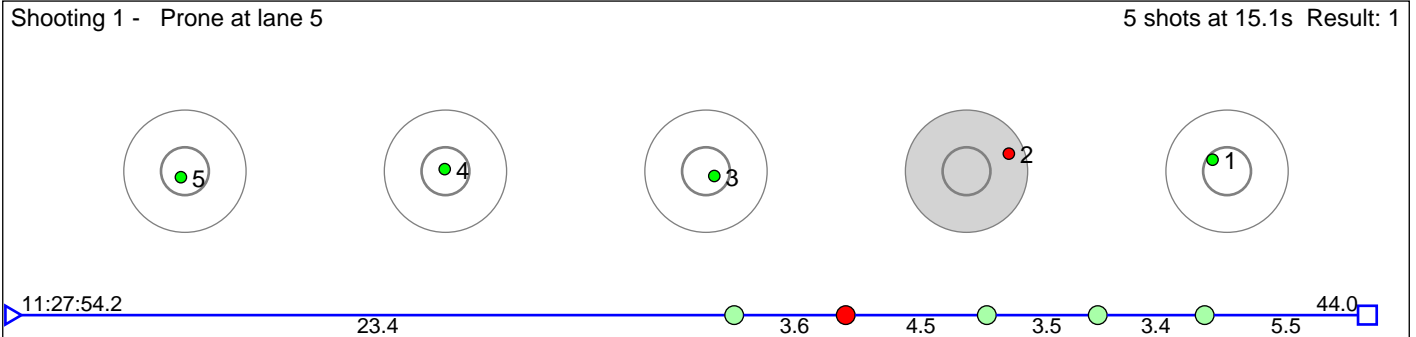

Disclaimer:

These results are unofficial since only the final output from the timing system can provide complete and correct competition results. The graphic plot of each series, presents the location of the shots on each of the five targets. Please observe that the accuracy of the plotting has some limitations due to image resolution and/or printer quality.

142 Flaa Marie Lund

Lørenskog Skiklubb

Result: 6

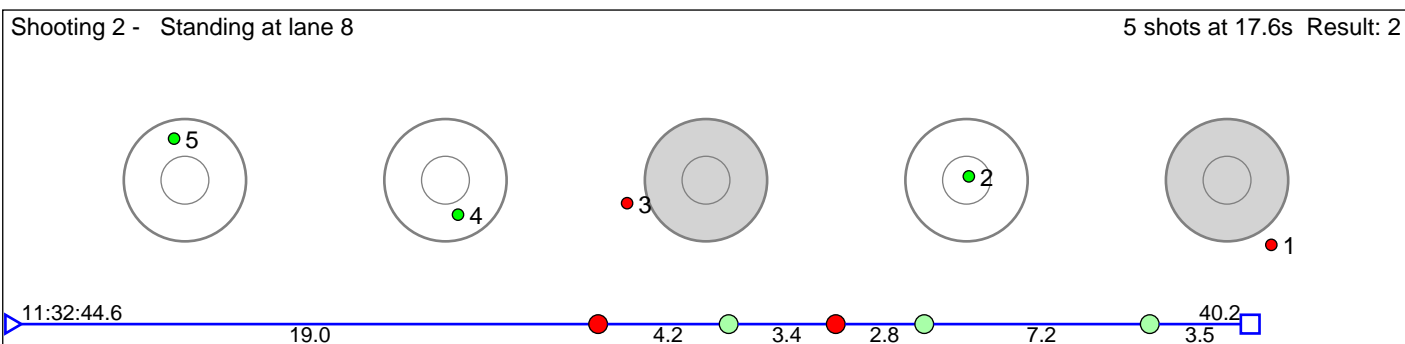
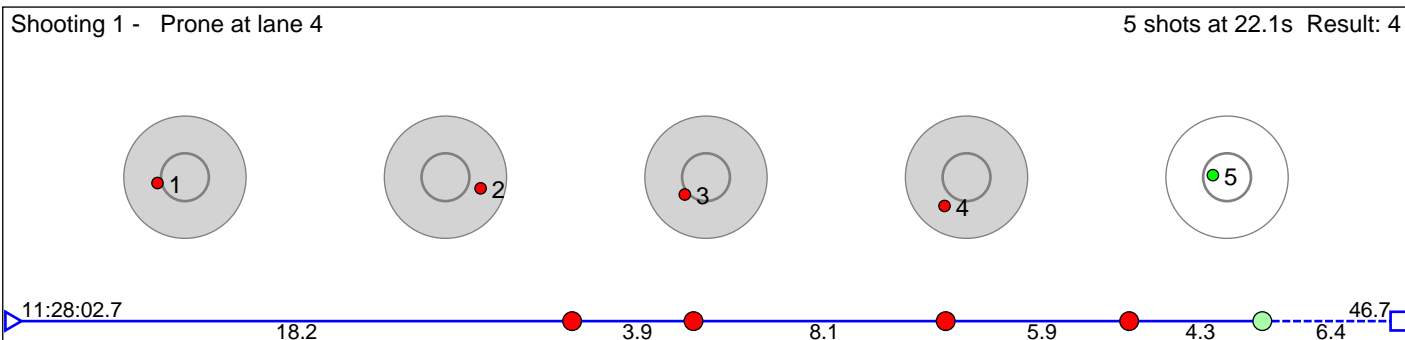

Disclaimer:

These results are unofficial since only the final output from the timing system can provide complete and correct competition results. The graphic plot of each series, presents the location of the shots on each of the five targets. Please observe that the accuracy of the plotting has some limitations due to image resolution and/or printer quality.

143 Tronrud Sara Agnethe Granvang

Nordre Land IL

Result: 3

Shooting 1 - Prone at lane 7

5 shots at 13.1s Result: 1

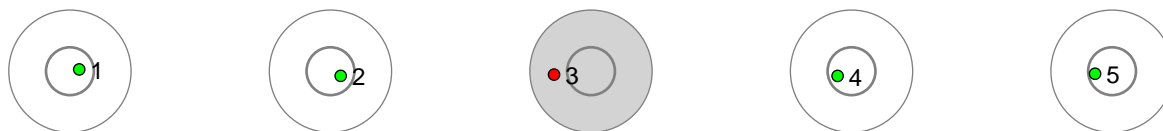

Shooting 2 - Standing at lane 13

5 shots at 13.8s Result: 2

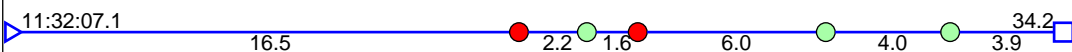
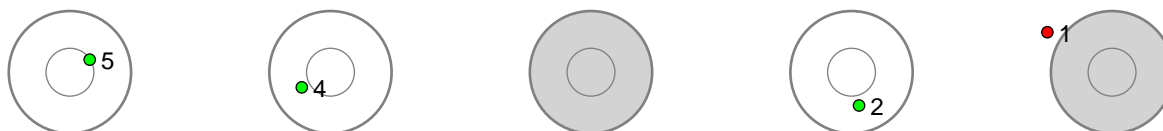

Disclaimer:

These results are unofficial since only the final output from the timing system can provide complete and correct competition results. The graphic plot of each series, presents the location of the shots on each of the five targets. Please observe that the accuracy of the plotting has some limitations due to image resolution and/or printer quality.

145 Kvelvane Julie Tronerud

Voss Skiskytterlag

Result: 2

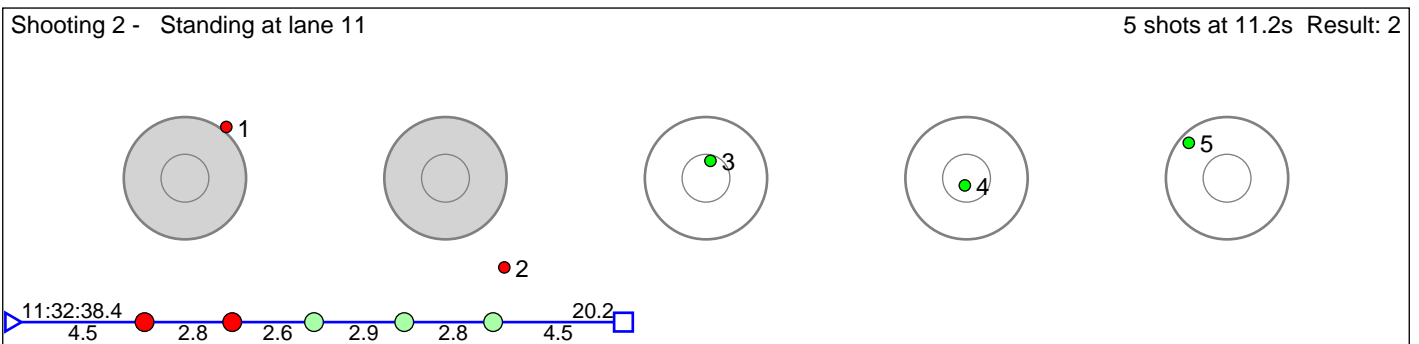
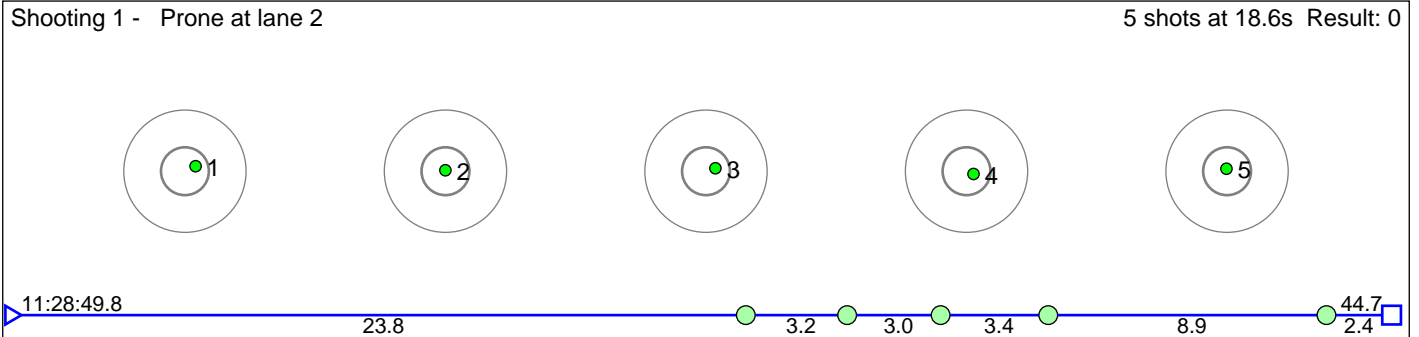

Disclaimer:

These results are unofficial since only the final output from the timing system can provide complete and correct competition results. The graphic plot of each series, presents the location of the shots on each of the five targets. Please observe that the accuracy of the plotting has some limitations due to image resolution and/or printer quality.

146 Jordal Ida Flatabø

Odda IL

Result: 4

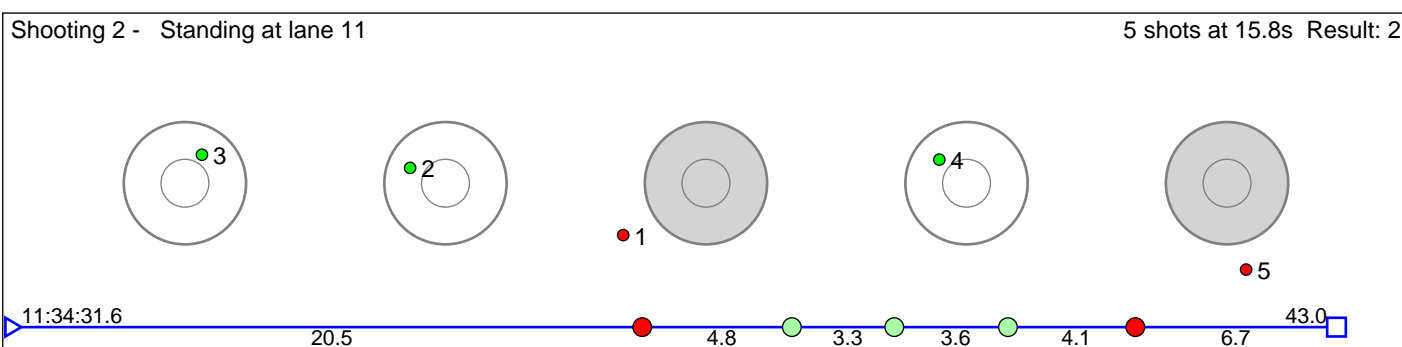
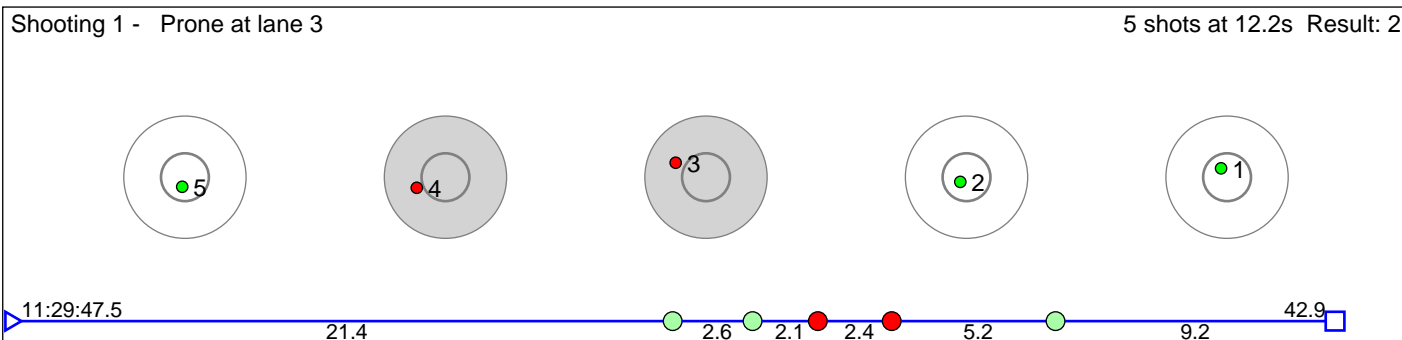

Disclaimer:

These results are unofficial since only the final output from the timing system can provide complete and correct competition results. The graphic plot of each series, presents the location of the shots on each of the five targets. Please observe that the accuracy of the plotting has some limitations due to image resolution and/or printer quality.

147 Fuglset Ida Madeleine

Nittedal Skiskytterlag

Result: 3

Shooting 1 - Prone at lane 4

5 shots at 19.5s Result: 1

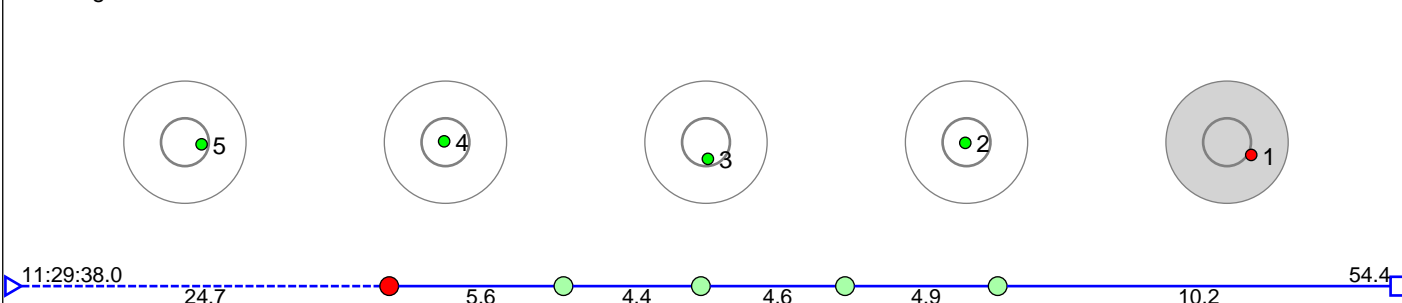

Shooting 2 - Standing at lane 9

5 shots at 21.2s Result: 2

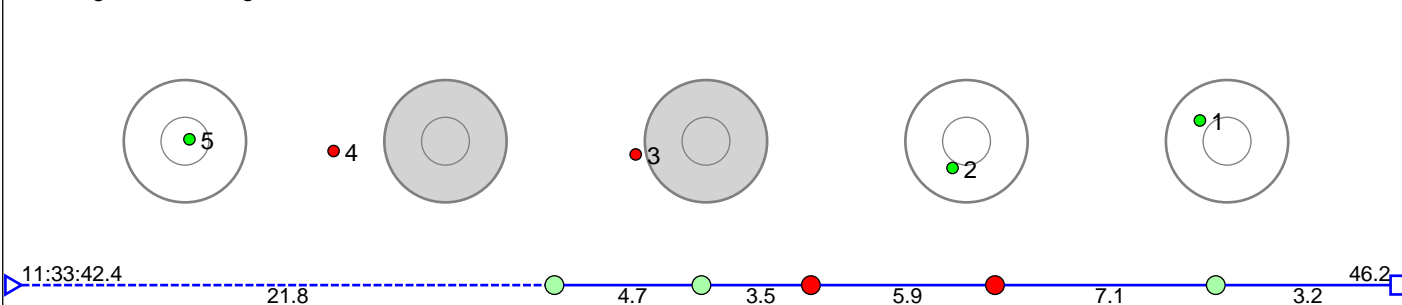

Disclaimer:

These results are unofficial since only the final output from the timing system can provide complete and correct competition results. The graphic plot of each series, presents the location of the shots on each of the five targets. Please observe that the accuracy of the plotting has some limitations due to image resolution and/or printer quality.

148 Berg-Knutsen Silje Christine

Fet Skiklubb

Result: 2

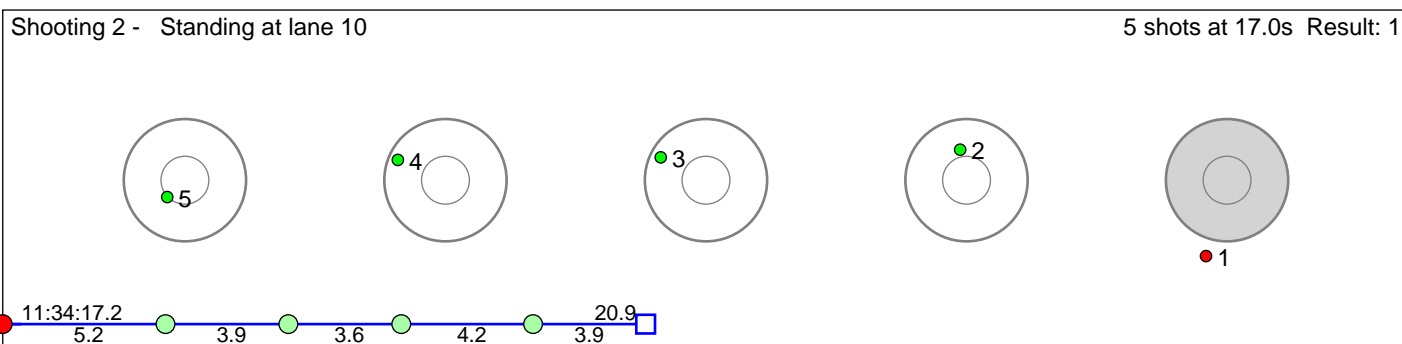
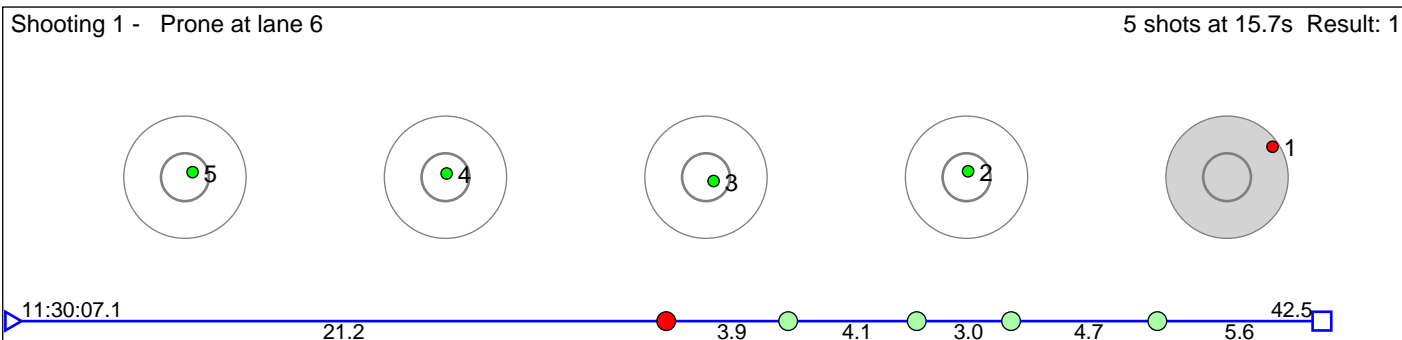

Disclaimer:

These results are unofficial since only the final output from the timing system can provide complete and correct competition results. The graphic plot of each series, presents the location of the shots on each of the five targets. Please observe that the accuracy of the plotting has some limitations due to image resolution and/or printer quality.

149 Boehlke Ine Lohne

Fossum IF

Result: 6

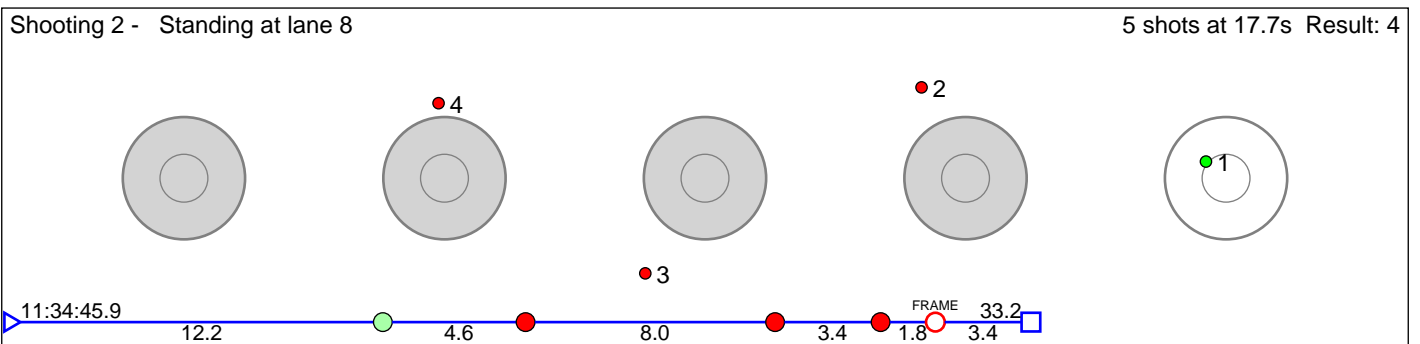
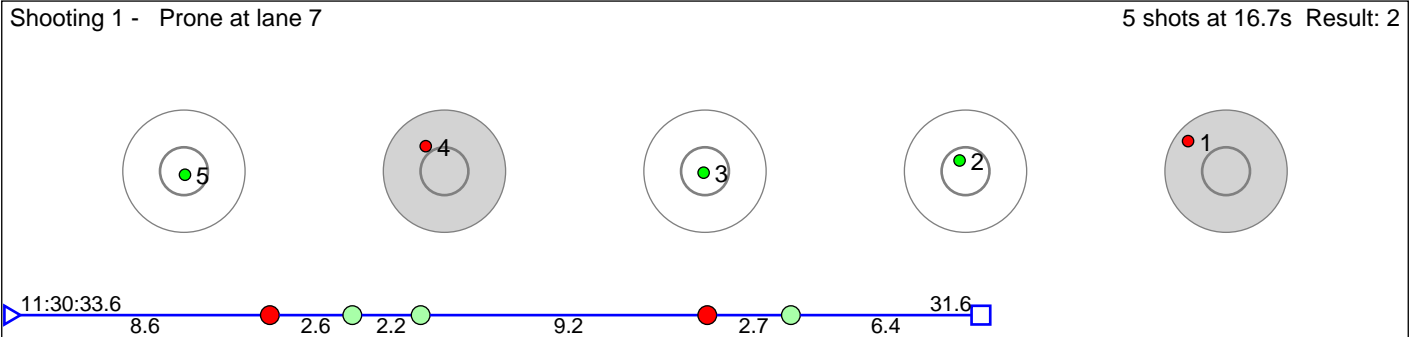

Disclaimer:

These results are unofficial since only the final output from the timing system can provide complete and correct competition results. The graphic plot of each series, presents the location of the shots on each of the five targets. Please observe that the accuracy of the plotting has some limitations due to image resolution and/or printer quality.

151 Kringler Anniken Dogger

Lørenskog Skiklubb

Result: 3

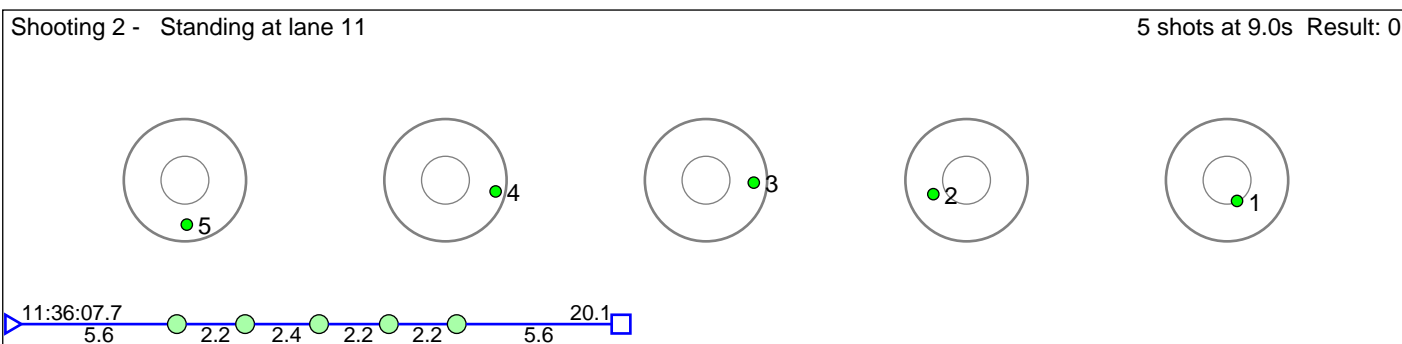
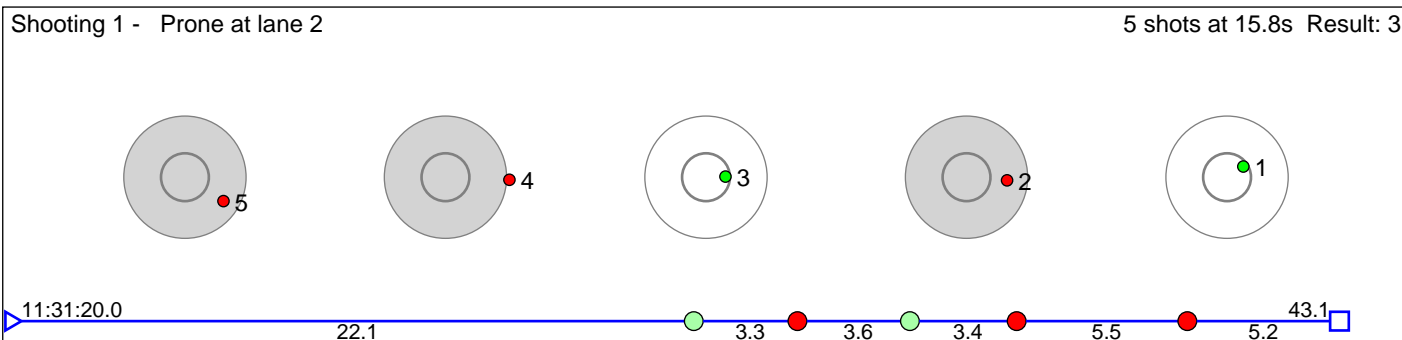

Disclaimer:

These results are unofficial since only the final output from the timing system can provide complete and correct competition results. The graphic plot of each series, presents the location of the shots on each of the five targets. Please observe that the accuracy of the plotting has some limitations due to image resolution and/or printer quality.

152 Strindeberg Guro Elizabeth

Drammen Strong

Result: 6

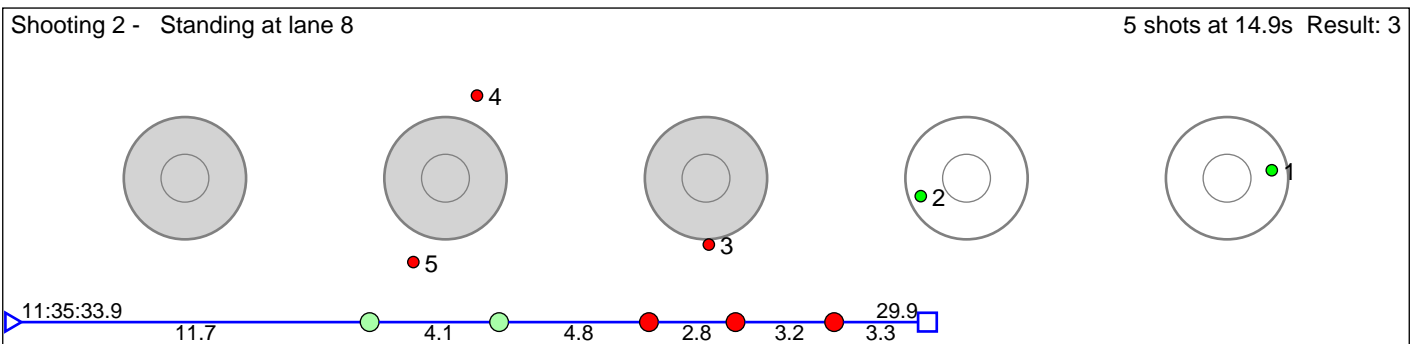
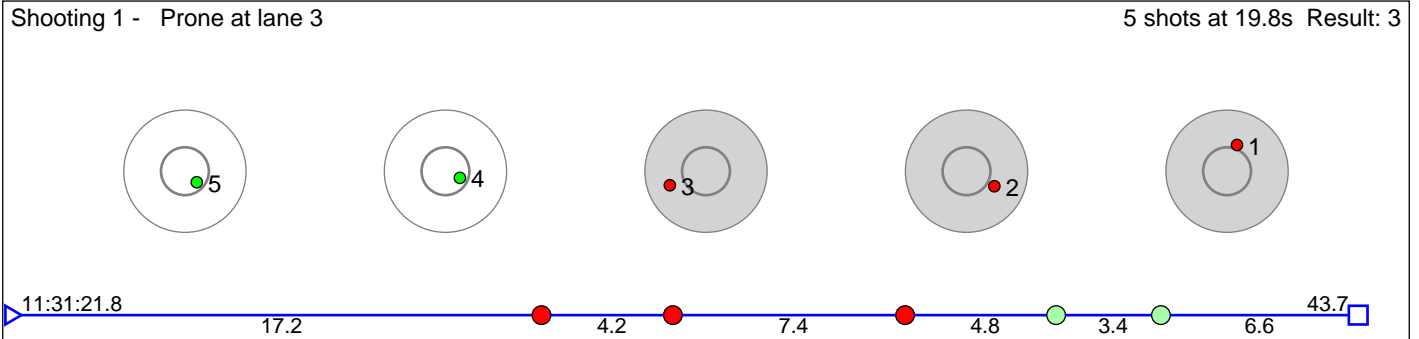

Disclaimer:

These results are unofficial since only the final output from the timing system can provide complete and correct competition results. The graphic plot of each series, presents the location of the shots on each of the five targets. Please observe that the accuracy of the plotting has some limitations due to image resolution and/or printer quality.

153 Ytterhus Nora

Rennebu IL

Result: 4

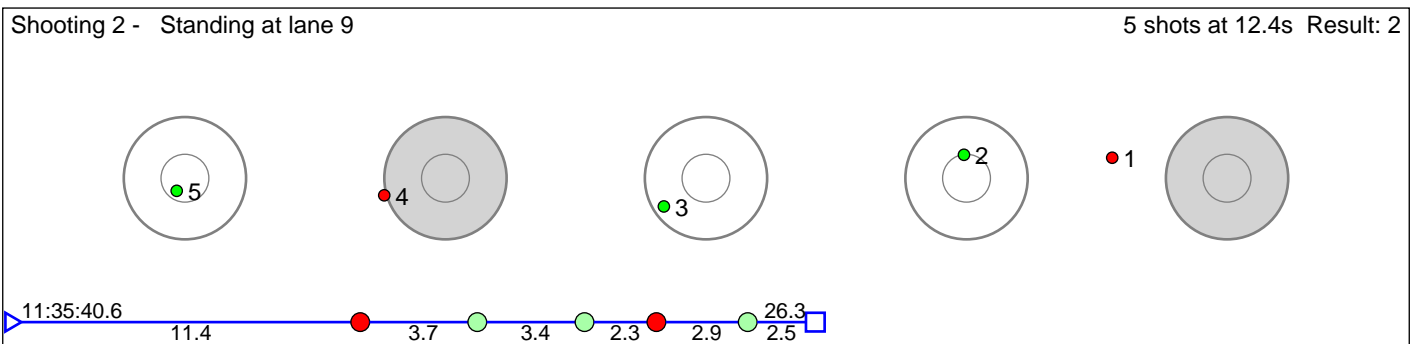
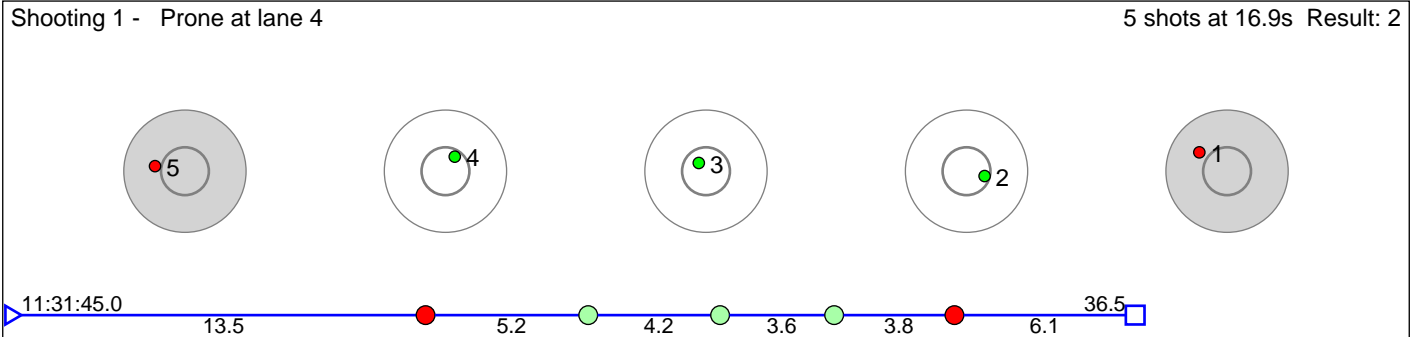

Disclaimer:

These results are unofficial since only the final output from the timing system can provide complete and correct competition results. The graphic plot of each series, presents the location of the shots on each of the five targets. Please observe that the accuracy of the plotting has some limitations due to image resolution and/or printer quality.

155 Randby Nora Njølstad

Ivrig IL

Result: 3

Shooting 1 - Prone at lane 5

5 shots at 8.4s Result: 0

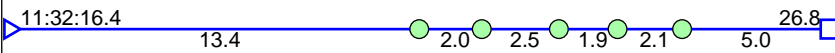
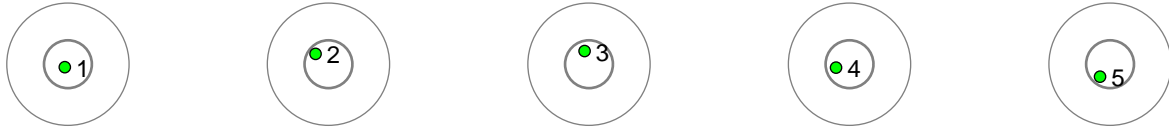

Shooting 2 - Standing at lane 10

5 shots at 9.9s Result: 3

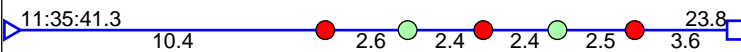
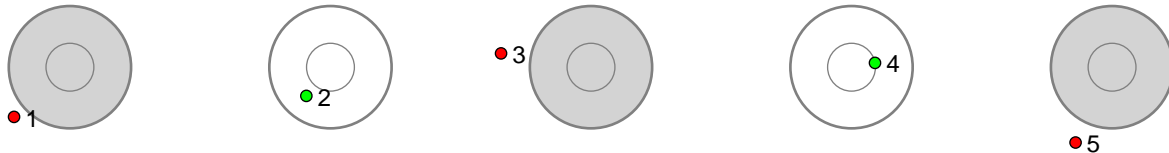

Disclaimer:

These results are unofficial since only the final output from the timing system can provide complete and correct competition results. The graphic plot of each series, presents the location of the shots on each of the five targets. Please observe that the accuracy of the plotting has some limitations due to image resolution and/or printer quality.

156 Dokken Maria Tormodsgard

Svene IL

Result: 1

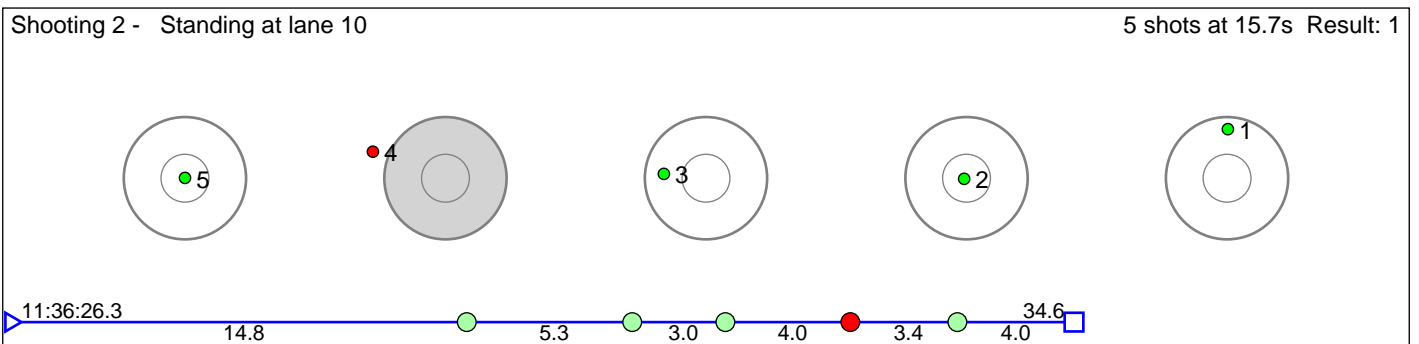
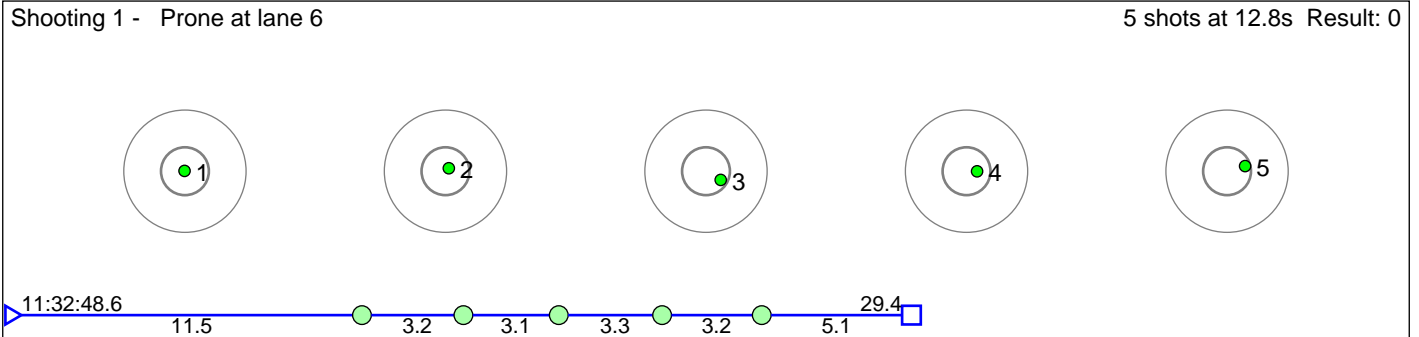

Disclaimer:

These results are unofficial since only the final output from the timing system can provide complete and correct competition results. The graphic plot of each series, presents the location of the shots on each of the five targets. Please observe that the accuracy of the plotting has some limitations due to image resolution and/or printer quality.

157 Almeland Andrea Sørheim

Kvam Langrenn- og Skiskyttarklubb

Result: 2

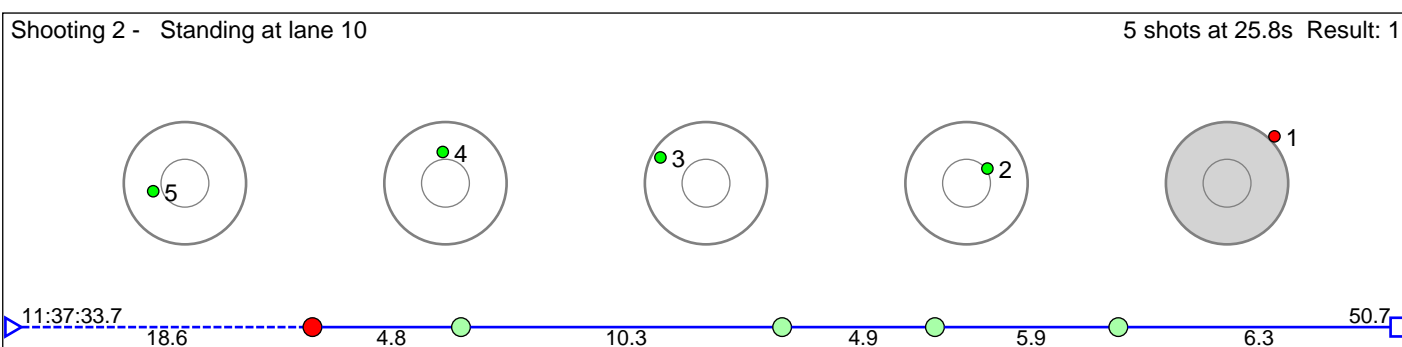
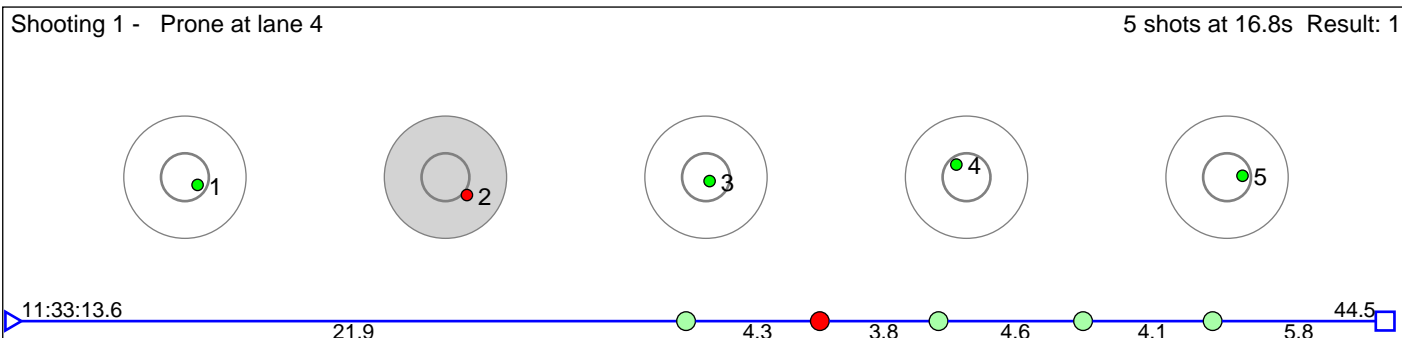

Disclaimer:

These results are unofficial since only the final output from the timing system can provide complete and correct competition results. The graphic plot of each series, presents the location of the shots on each of the five targets. Please observe that the accuracy of the plotting has some limitations due to image resolution and/or printer quality.

158 Noraberg Eline

Seljord Idrettslag

Result: 4

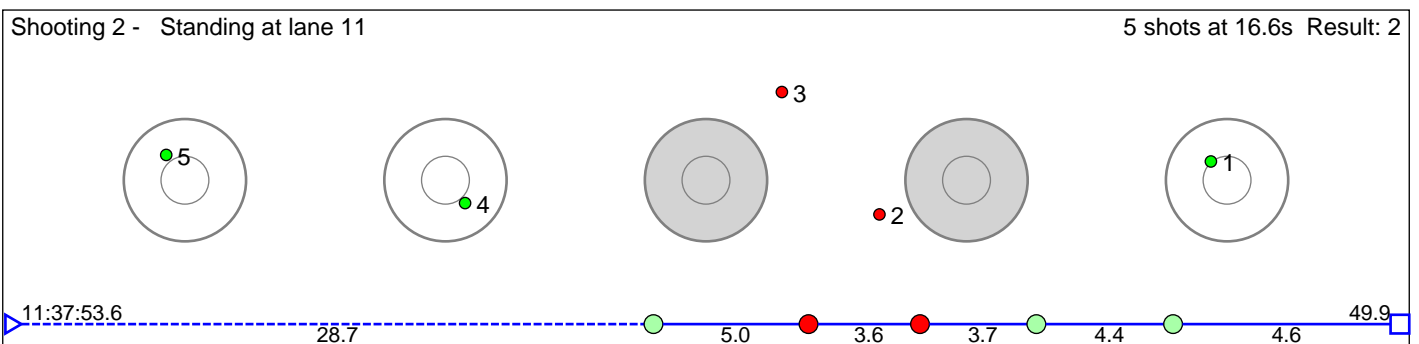
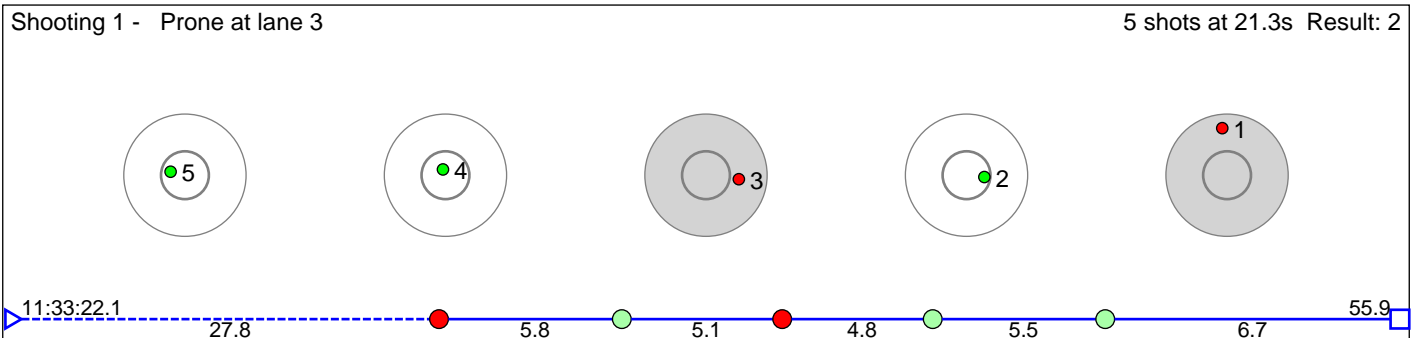

Disclaimer:

These results are unofficial since only the final output from the timing system can provide complete and correct competition results. The graphic plot of each series, presents the location of the shots on each of the five targets. Please observe that the accuracy of the plotting has some limitations due to image resolution and/or printer quality.

159 Aas Lena

Birkenes IL

Result: 6

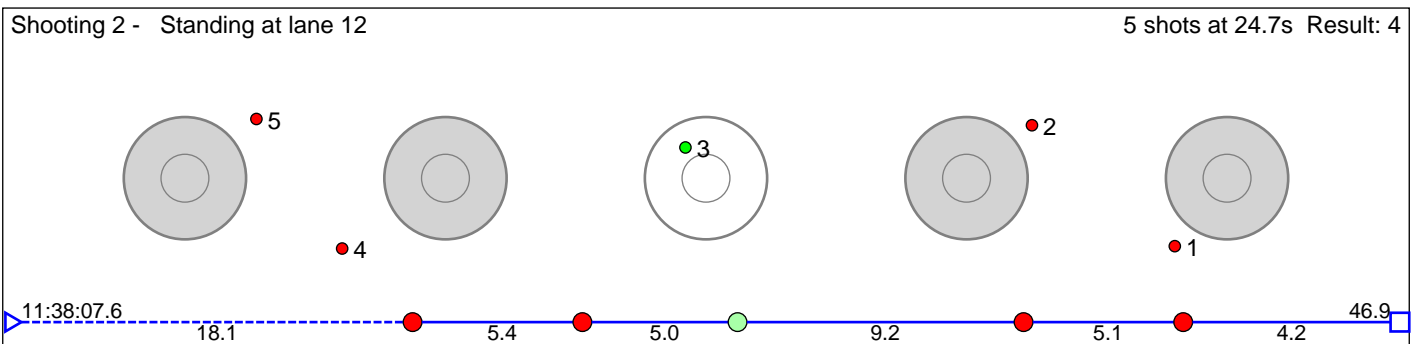
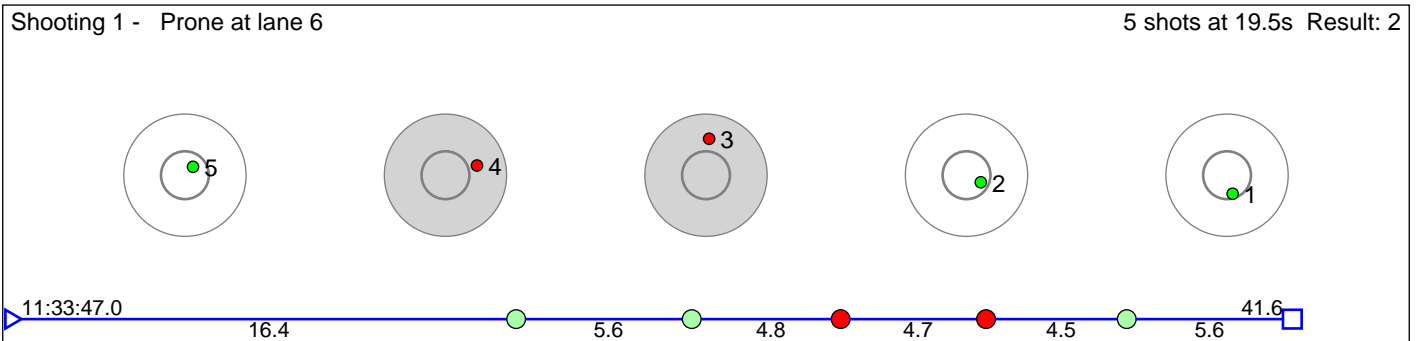

Disclaimer:

These results are unofficial since only the final output from the timing system can provide complete and correct competition results. The graphic plot of each series, presents the location of the shots on each of the five targets. Please observe that the accuracy of the plotting has some limitations due to image resolution and/or printer quality.

160 Engevik Sturla Oma

Drammen Strong

Result: 10

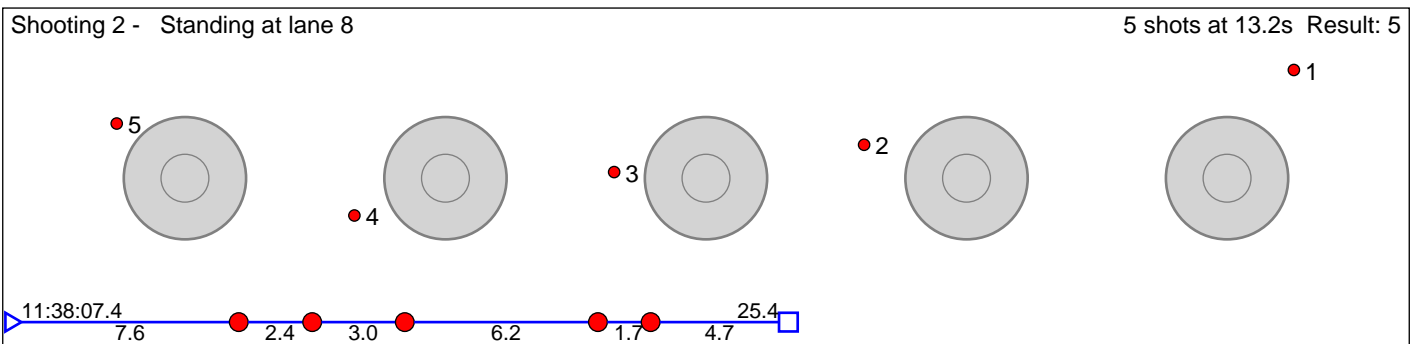
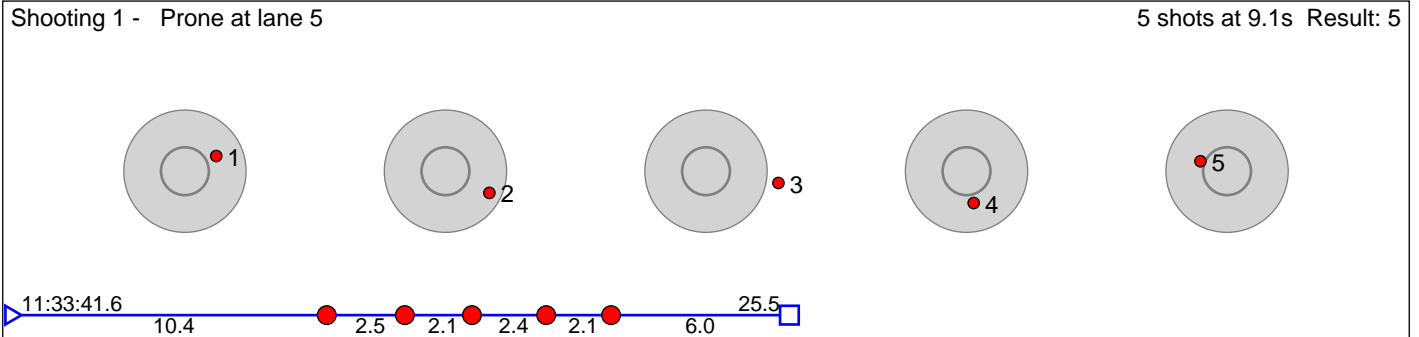

Disclaimer:

These results are unofficial since only the final output from the timing system can provide complete and correct competition results. The graphic plot of each series, presents the location of the shots on each of the five targets. Please observe that the accuracy of the plotting has some limitations due to image resolution and/or printer quality.

162 Gigstad-Bergene Tobias

Skrautvål IL

Result: 4

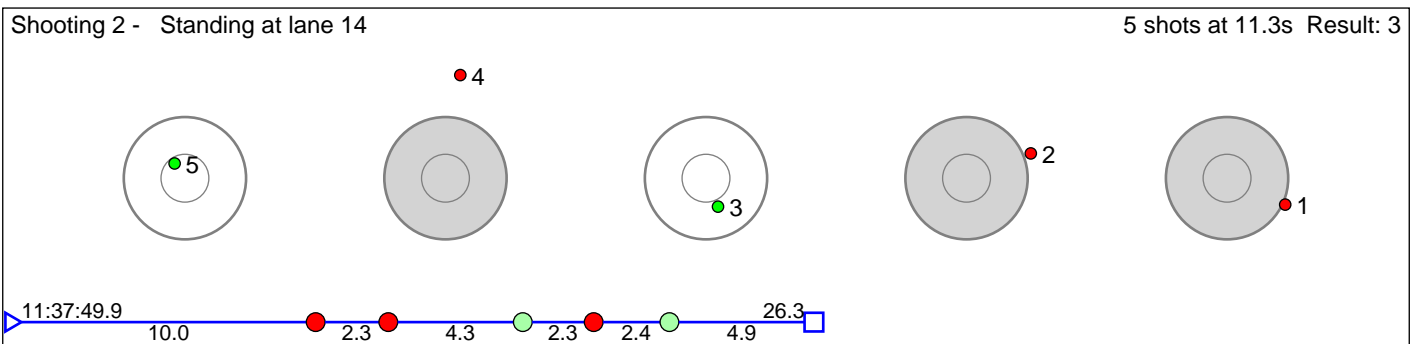
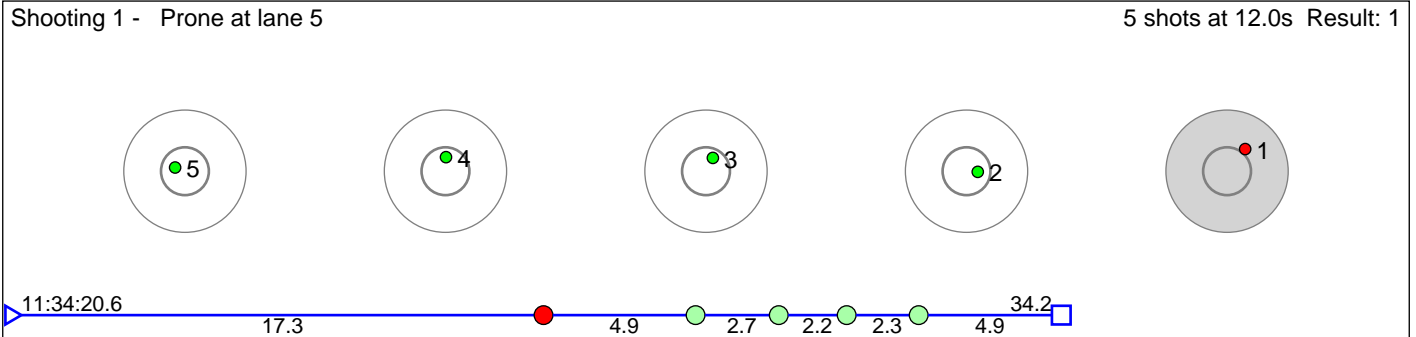

Disclaimer:

These results are unofficial since only the final output from the timing system can provide complete and correct competition results. The graphic plot of each series, presents the location of the shots on each of the five targets. Please observe that the accuracy of the plotting has some limitations due to image resolution and/or printer quality.

163 Jøsang Sivert

Sandnes og Gjesdal SSL

Result: 4

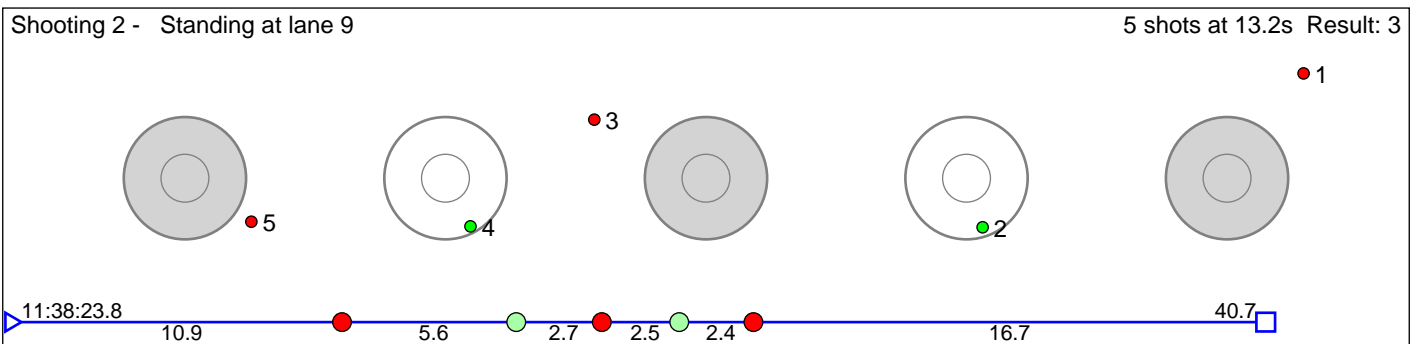
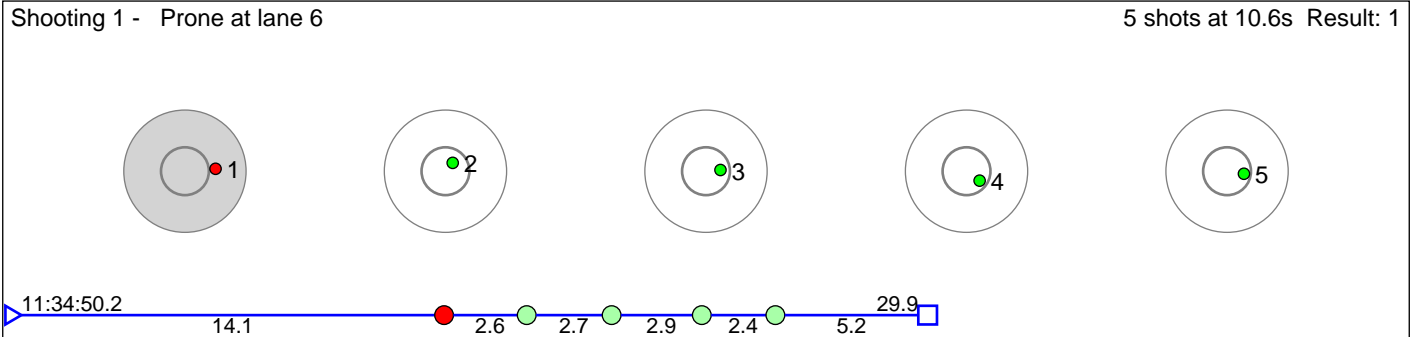

Disclaimer:

These results are unofficial since only the final output from the timing system can provide complete and correct competition results. The graphic plot of each series, presents the location of the shots on each of the five targets. Please observe that the accuracy of the plotting has some limitations due to image resolution and/or printer quality.

164 Ueland Adrian

Sandnes og Gjesdal SSL

Result: 2

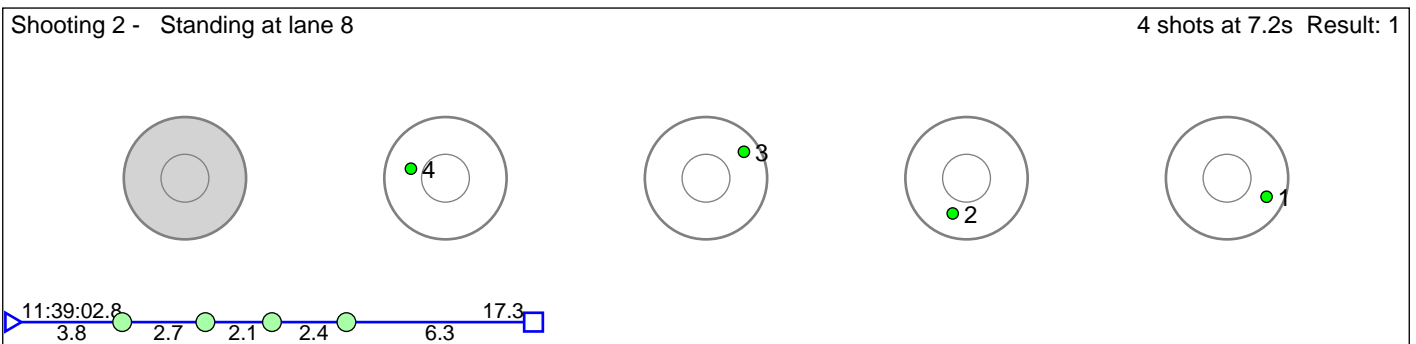
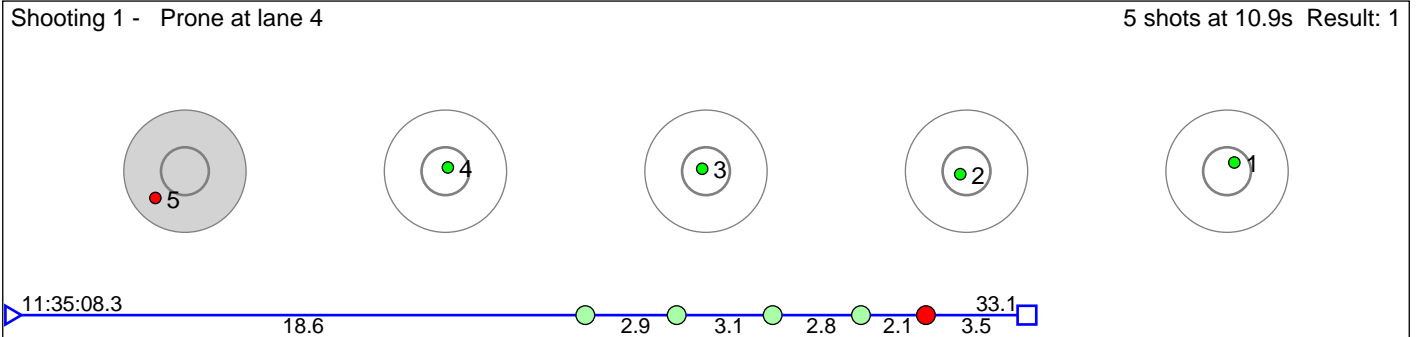

Disclaimer:

These results are unofficial since only the final output from the timing system can provide complete and correct competition results. The graphic plot of each series, presents the location of the shots on each of the five targets. Please observe that the accuracy of the plotting has some limitations due to image resolution and/or printer quality.

165 Hallingstad Olav

Bærums Skiklub

Result: 2

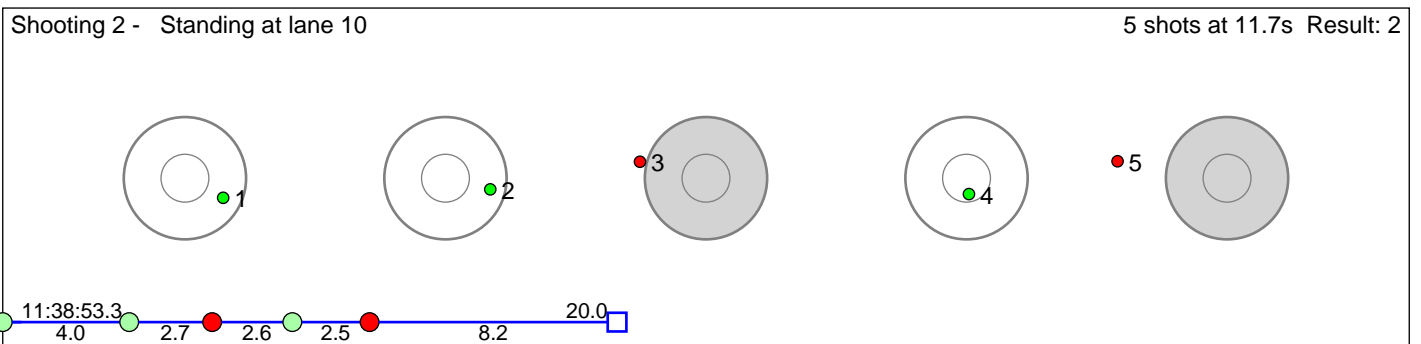
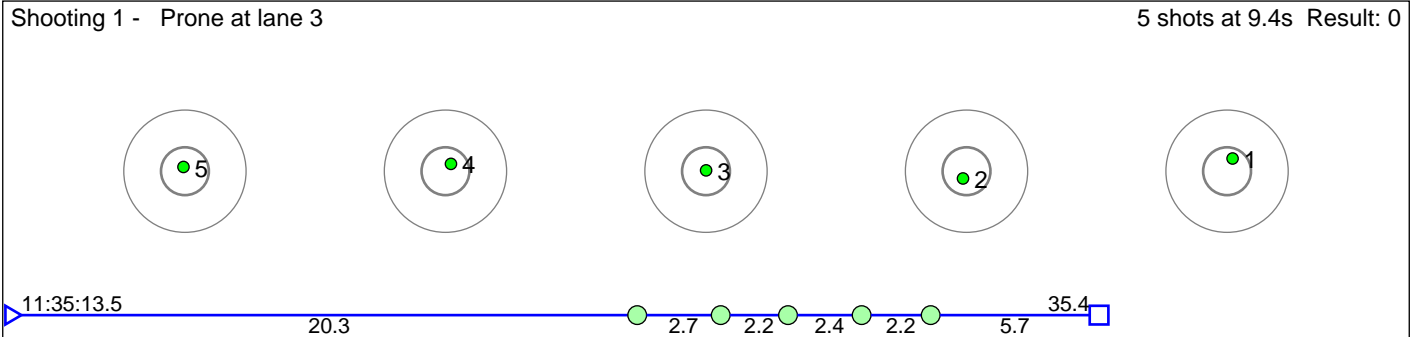

Disclaimer:

These results are unofficial since only the final output from the timing system can provide complete and correct competition results. The graphic plot of each series, presents the location of the shots on each of the five targets. Please observe that the accuracy of the plotting has some limitations due to image resolution and/or printer quality.

166 Nilsen Sondre Sangvik

Øvrebø IL

Result: 3

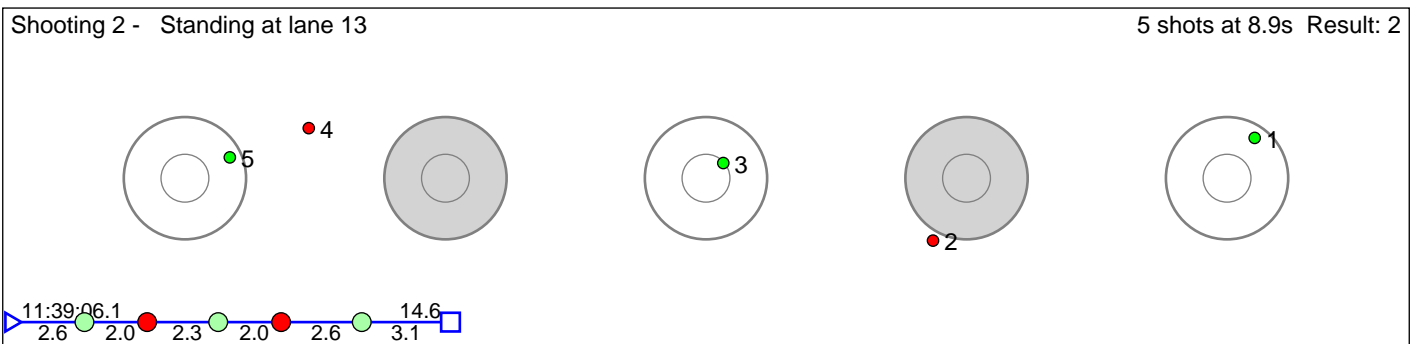
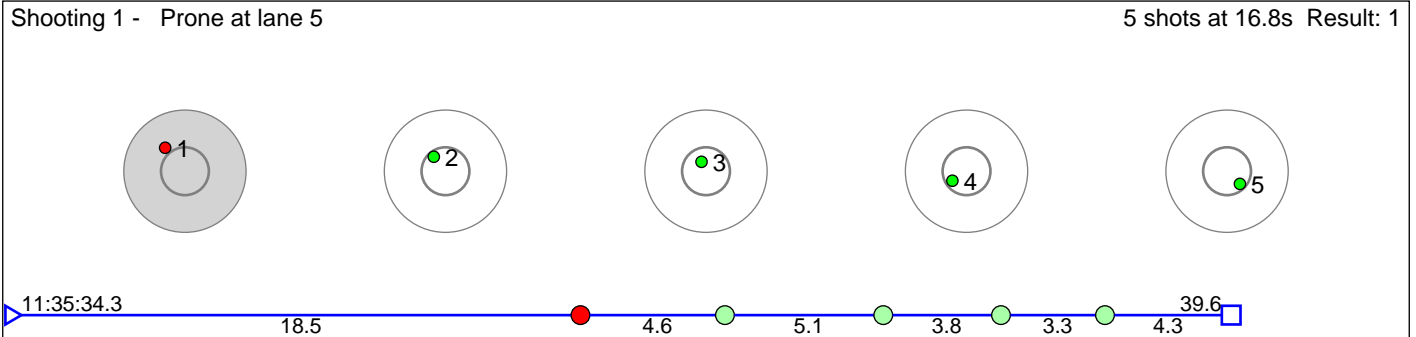

Disclaimer:

These results are unofficial since only the final output from the timing system can provide complete and correct competition results. The graphic plot of each series, presents the location of the shots on each of the five targets. Please observe that the accuracy of the plotting has some limitations due to image resolution and/or printer quality.

167 Bjelland Kevin Brun

Sandnes og Gjesdal SSL

Result: 3

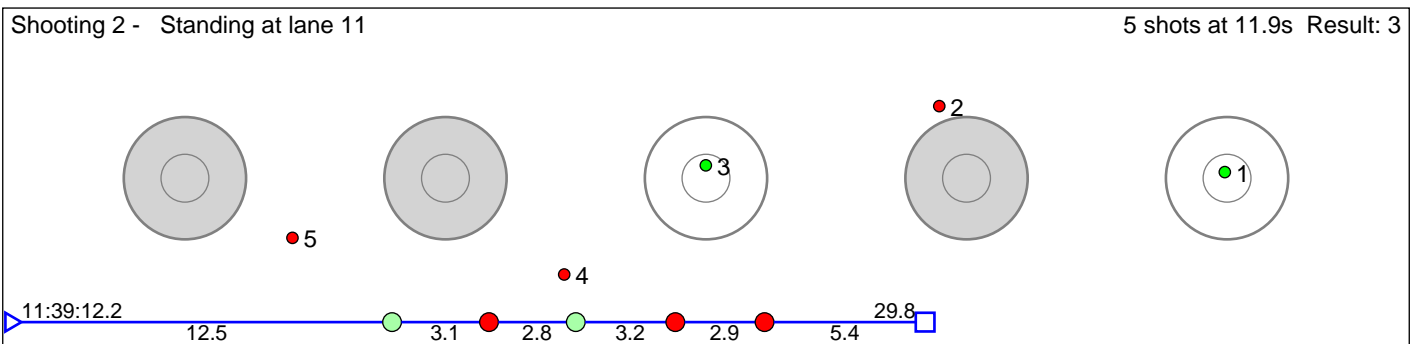
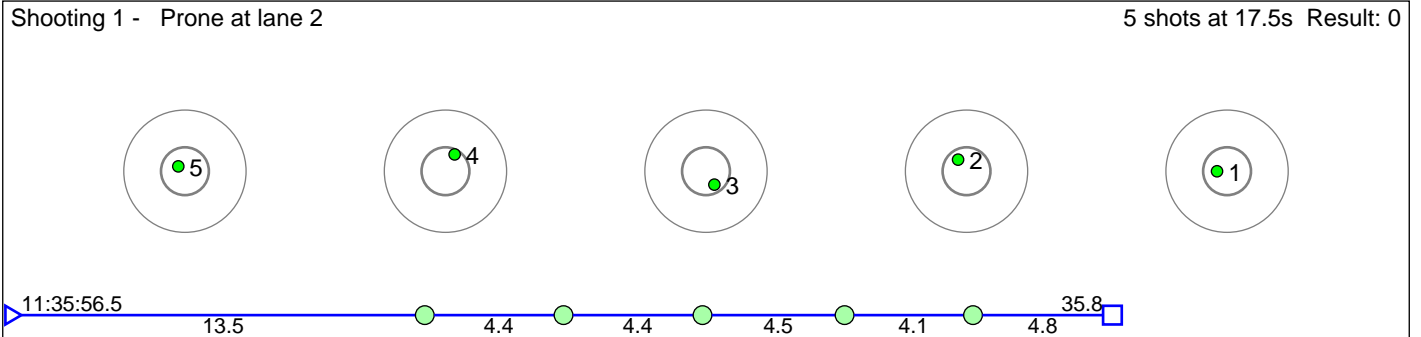

Disclaimer:

These results are unofficial since only the final output from the timing system can provide complete and correct competition results. The graphic plot of each series, presents the location of the shots on each of the five targets. Please observe that the accuracy of the plotting has some limitations due to image resolution and/or printer quality.

168 Mccarthy Thomas

Asker Skiklubb

Result: 4

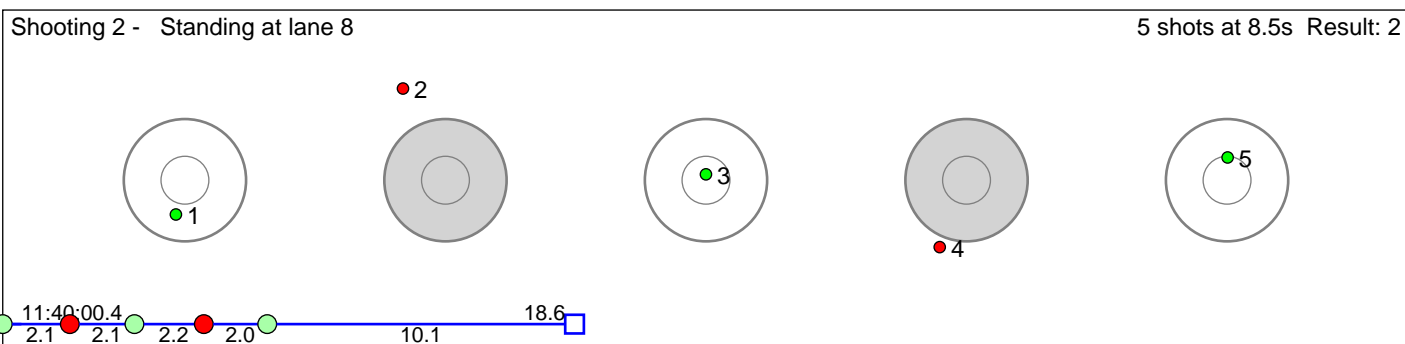
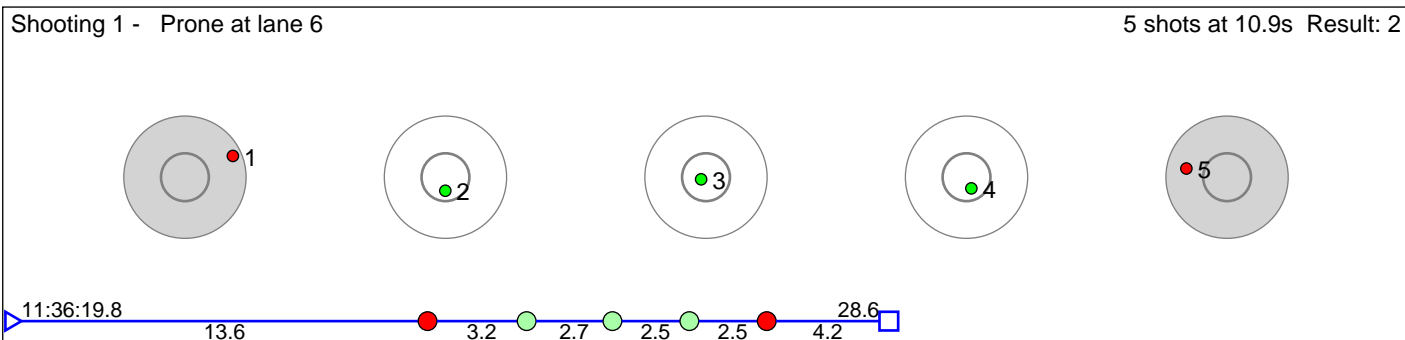

Disclaimer:

These results are unofficial since only the final output from the timing system can provide complete and correct competition results. The graphic plot of each series, presents the location of the shots on each of the five targets. Please observe that the accuracy of the plotting has some limitations due to image resolution and/or printer quality.

169 Ustad Håkon Milliam

Ivrig IL

Result: 2

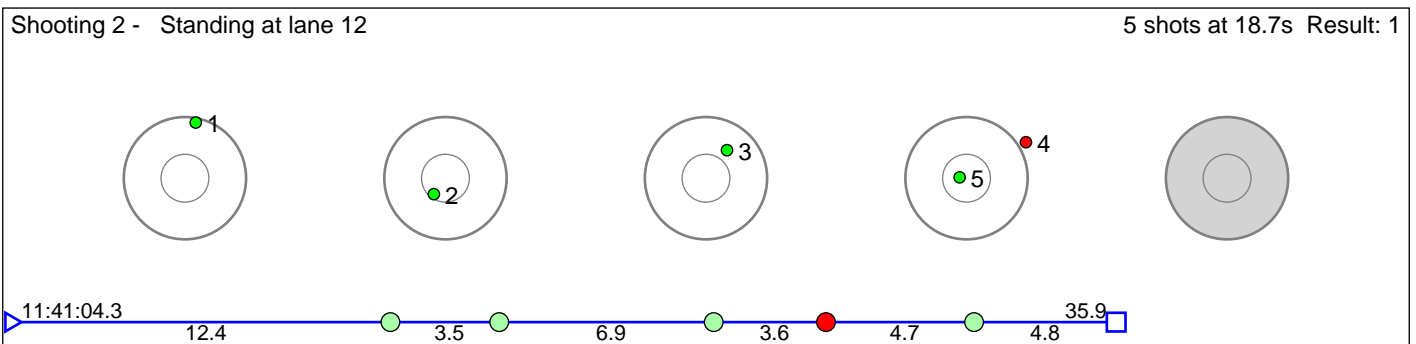
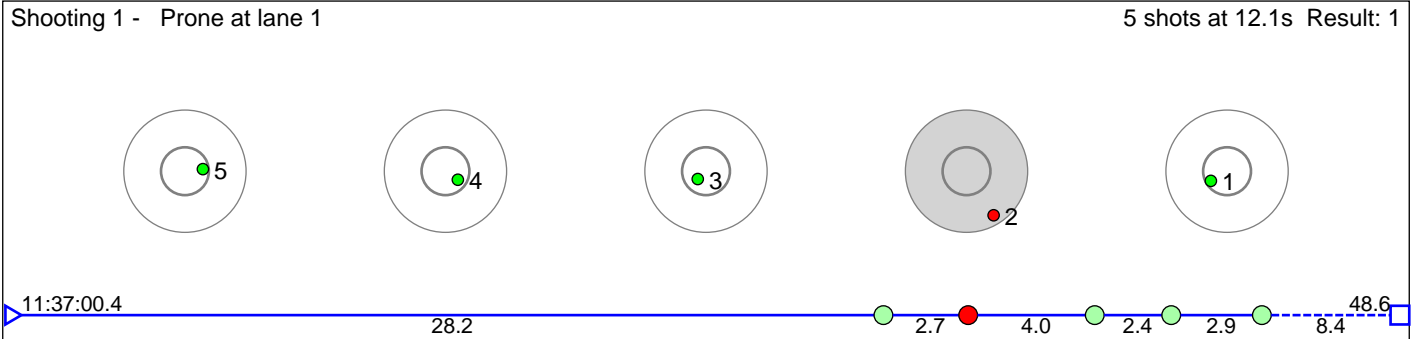

Disclaimer:

These results are unofficial since only the final output from the timing system can provide complete and correct competition results. The graphic plot of each series, presents the location of the shots on each of the five targets. Please observe that the accuracy of the plotting has some limitations due to image resolution and/or printer quality.

170 Moslet Elias

Fossum IF

Result: 4

Shooting 1 - Prone at lane 2

5 shots at 12.5s Result: 2

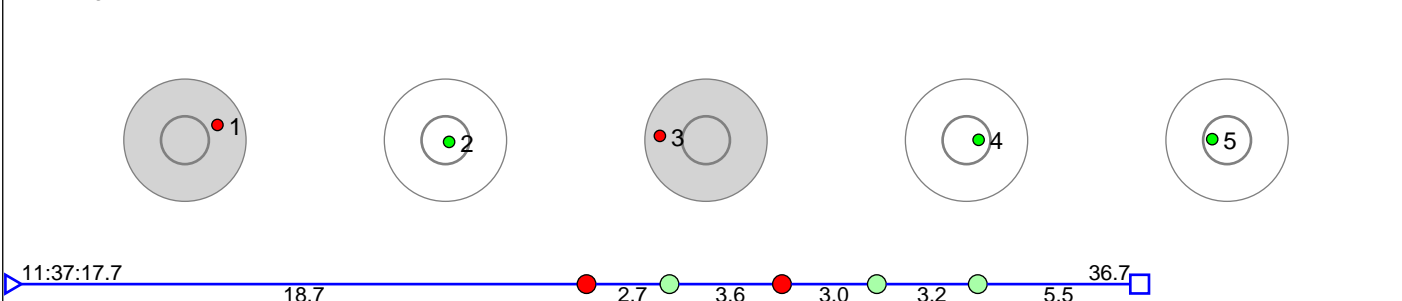

Shooting 2 - Standing at lane 13

5 shots at 10.9s Result: 2

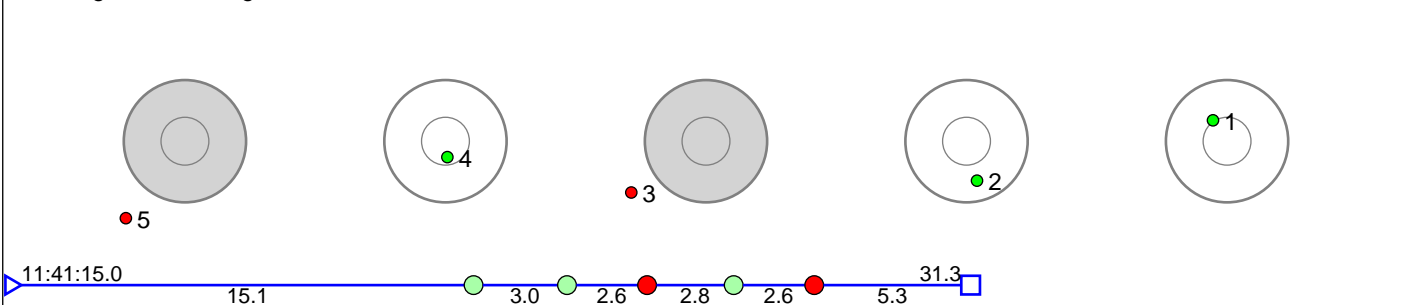

Disclaimer:

These results are unofficial since only the final output from the timing system can provide complete and correct competition results. The graphic plot of each series, presents the location of the shots on each of the five targets. Please observe that the accuracy of the plotting has some limitations due to image resolution and/or printer quality.

171 Hernes Simon Gunnar

Fossum IF

Result: 6

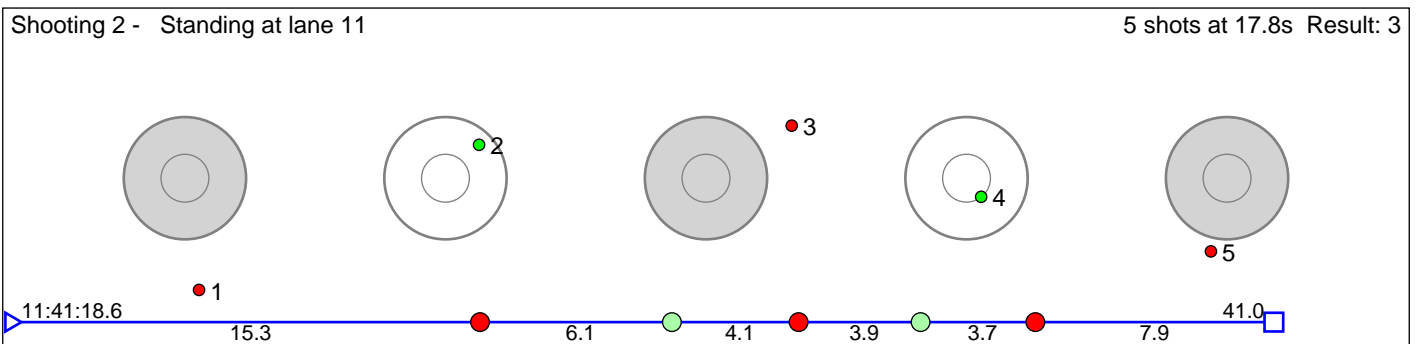
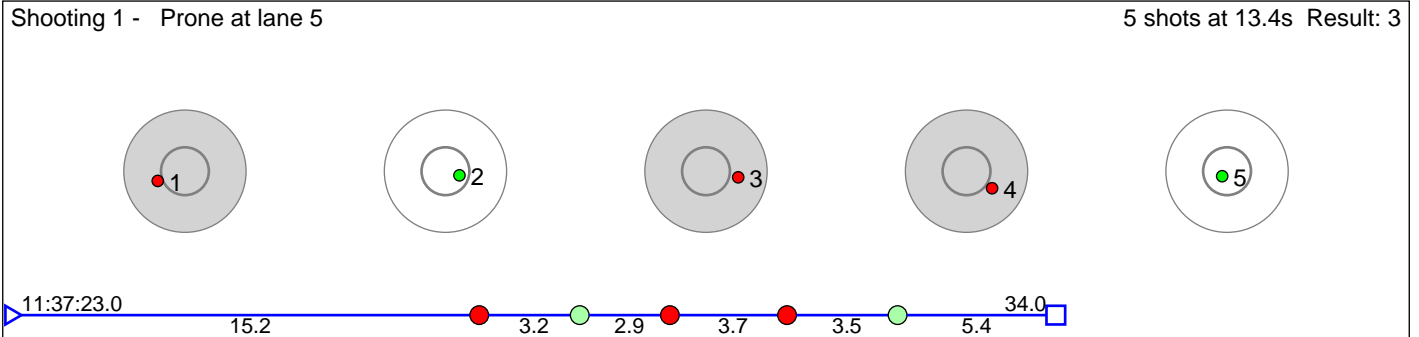

Disclaimer:

These results are unofficial since only the final output from the timing system can provide complete and correct competition results. The graphic plot of each series, presents the location of the shots on each of the five targets. Please observe that the accuracy of the plotting has some limitations due to image resolution and/or printer quality.

172 Skogrand Isak

Oppdal IL

Result: 4

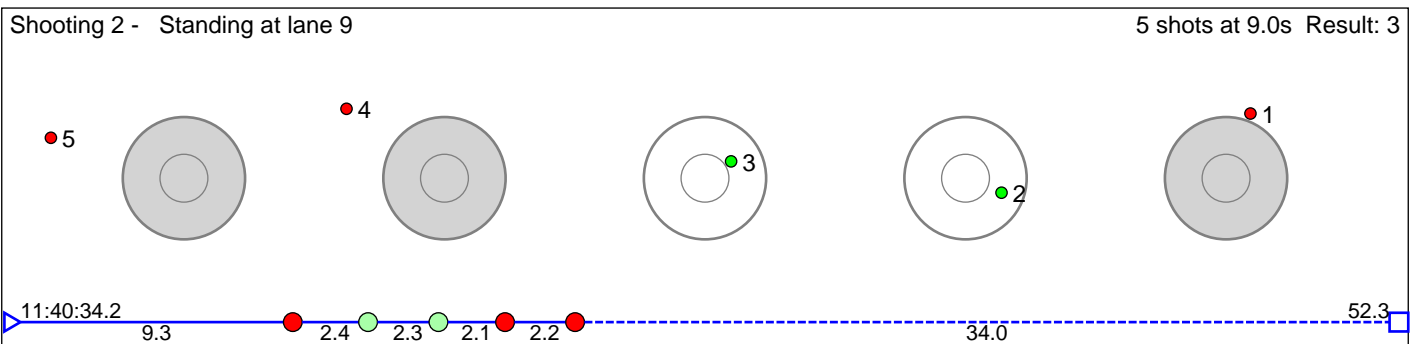
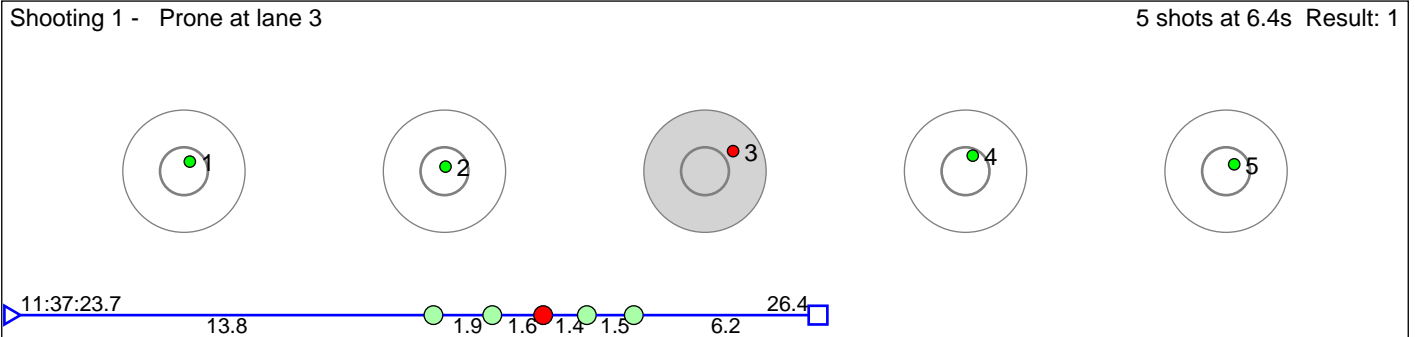

Disclaimer:

These results are unofficial since only the final output from the timing system can provide complete and correct competition results. The graphic plot of each series, presents the location of the shots on each of the five targets. Please observe that the accuracy of the plotting has some limitations due to image resolution and/or printer quality.

174 Samseth Oscar Magnus

Bærums Skiklub

Result: 4

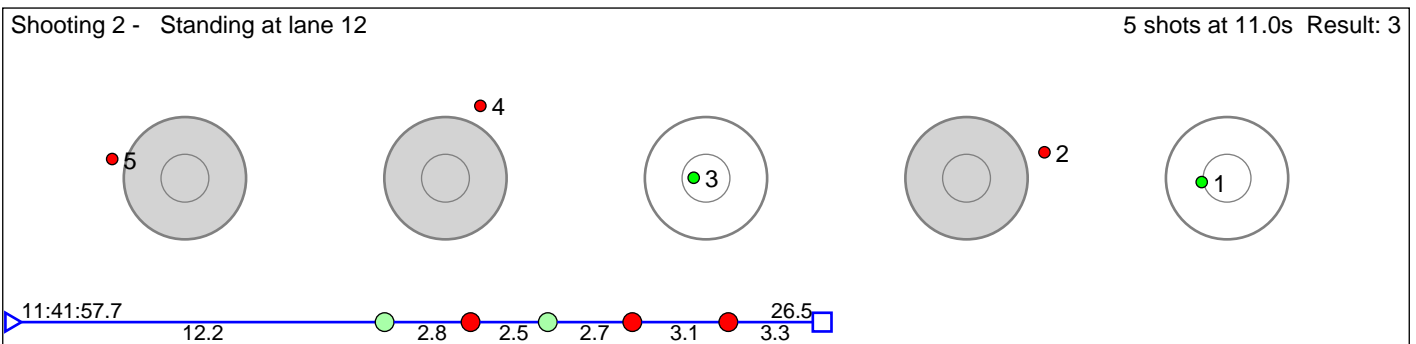
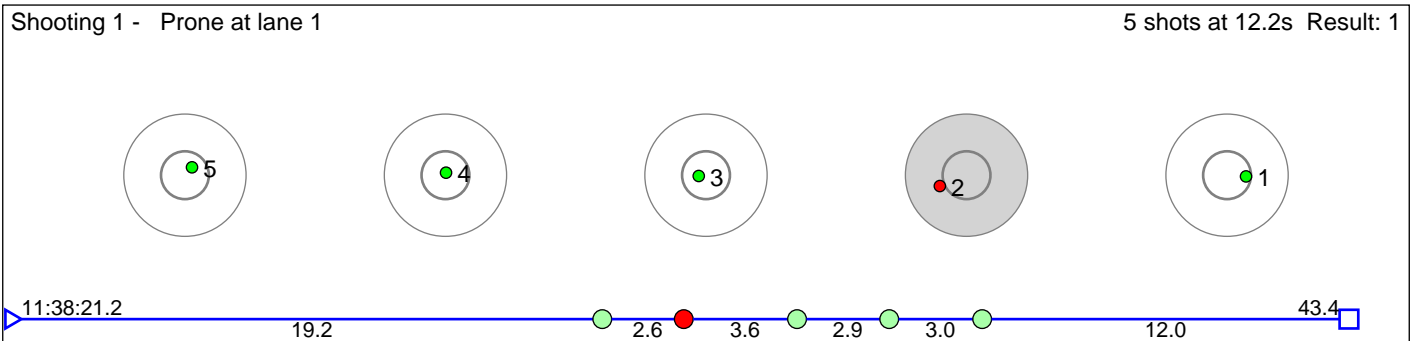

Disclaimer:

These results are unofficial since only the final output from the timing system can provide complete and correct competition results. The graphic plot of each series, presents the location of the shots on each of the five targets. Please observe that the accuracy of the plotting has some limitations due to image resolution and/or printer quality.

176 Haugstad Elias

Figgjo IL

Result: 4

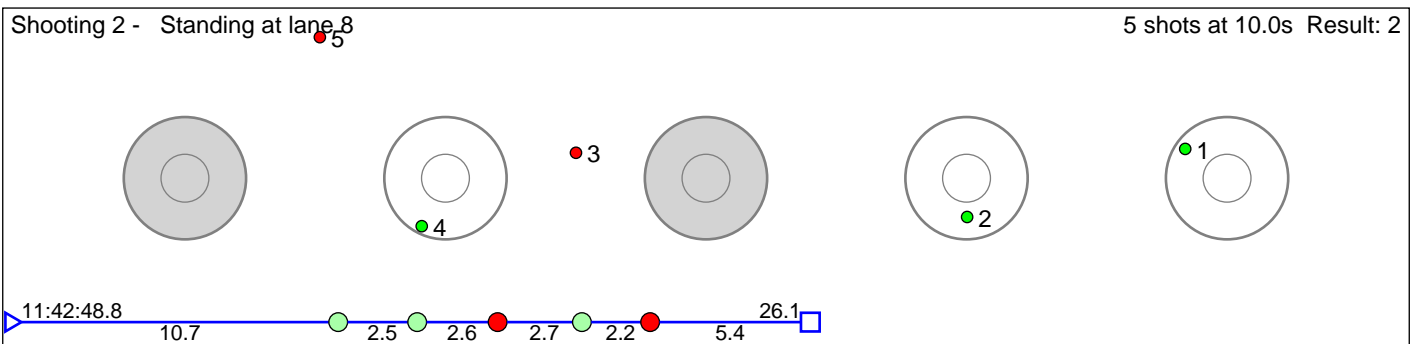
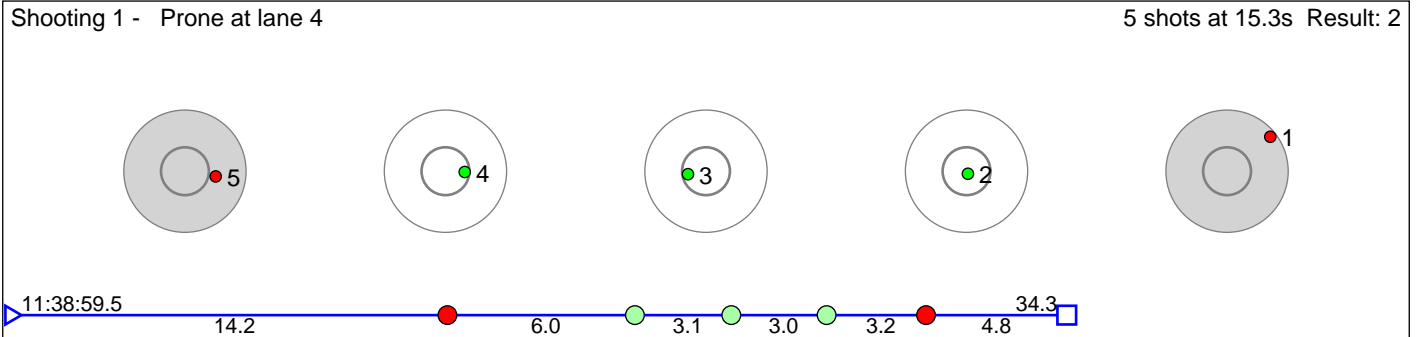

Disclaimer:

These results are unofficial since only the final output from the timing system can provide complete and correct competition results. The graphic plot of each series, presents the location of the shots on each of the five targets. Please observe that the accuracy of the plotting has some limitations due to image resolution and/or printer quality.

177 Fidjeland Marius Nygård

Sirdal Skilag

Result: 7

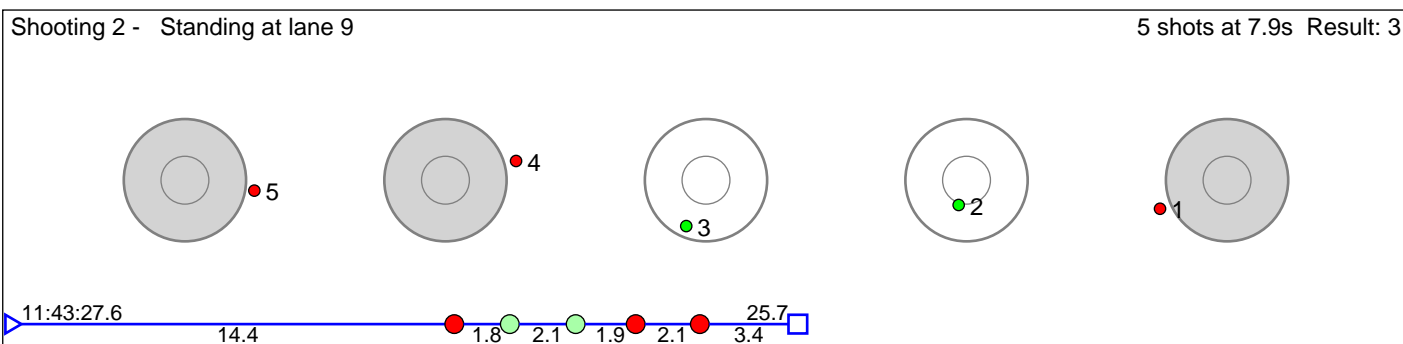
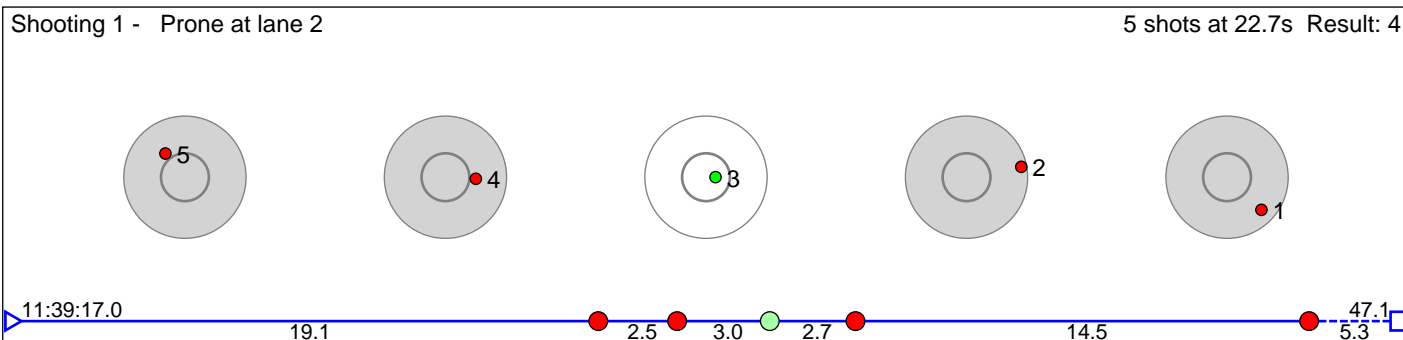

Disclaimer:

These results are unofficial since only the final output from the timing system can provide complete and correct competition results. The graphic plot of each series, presents the location of the shots on each of the five targets. Please observe that the accuracy of the plotting has some limitations due to image resolution and/or printer quality.

179 Koksvik Torbjørn

Figgjo IL

Result: 6

Shooting 1 - Prone at lane 3

5 shots at 9.3s Result: 2

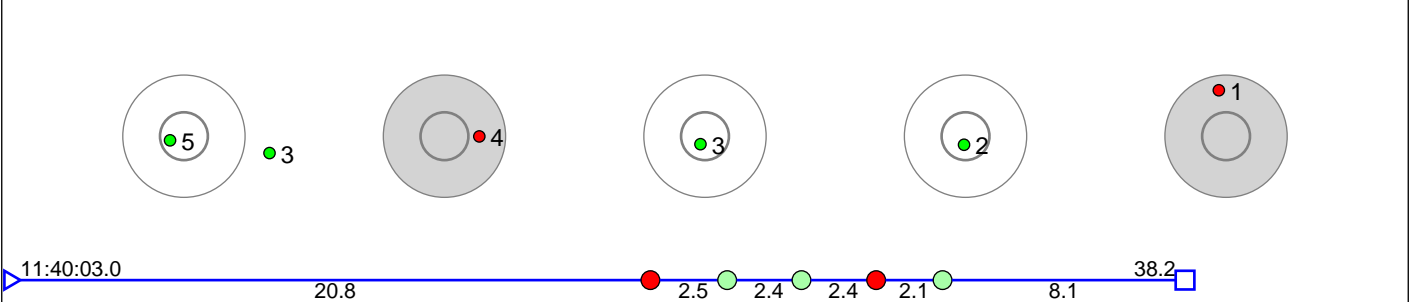

Shooting 2 - Standing at lane 10

5 shots at 17.9s Result: 4

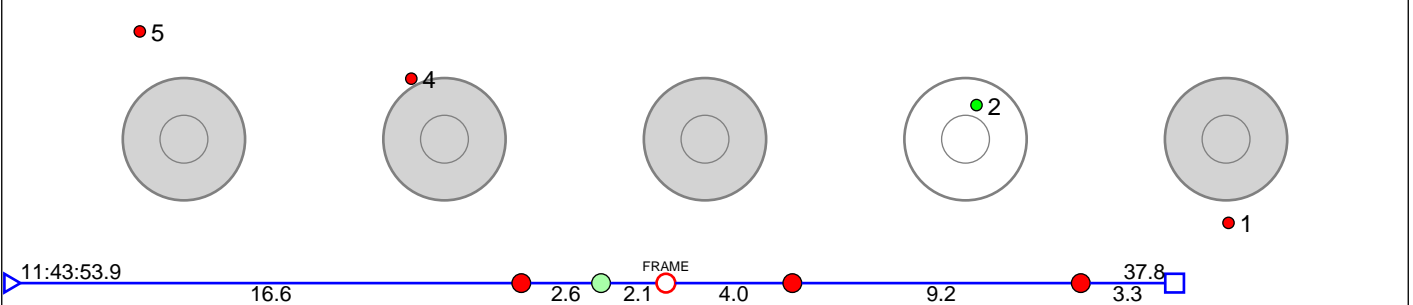

Disclaimer:

These results are unofficial since only the final output from the timing system can provide complete and correct competition results. The graphic plot of each series, presents the location of the shots on each of the five targets. Please observe that the accuracy of the plotting has some limitations due to image resolution and/or printer quality.

180 Horn Vebjørn

Ivrig IL

Result: 8

Shooting 1 - Prone at lane 6

5 shots at 12.6s Result: 5

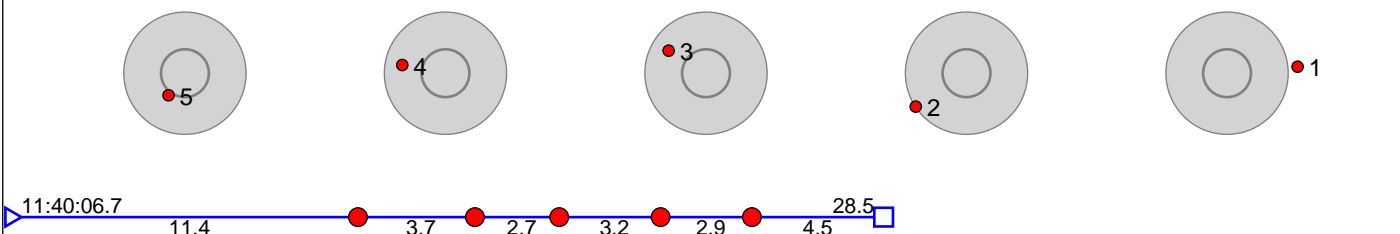

Shooting 2 - Standing at lane 11

5 shots at 11.7s Result: 3

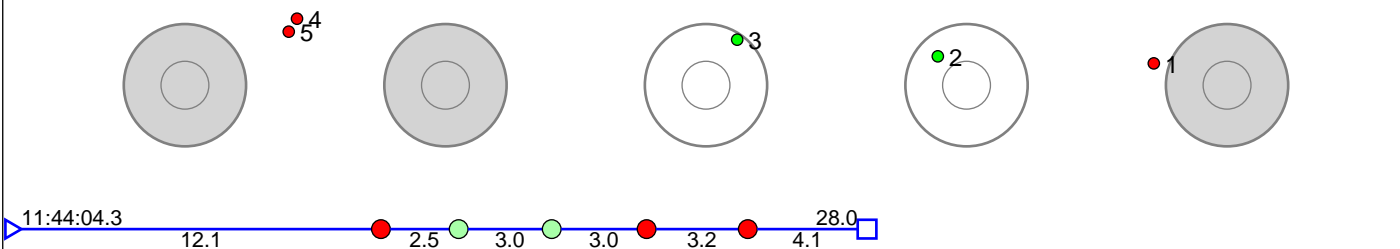

Disclaimer:

These results are unofficial since only the final output from the timing system can provide complete and correct competition results. The graphic plot of each series, presents the location of the shots on each of the five targets. Please observe that the accuracy of the plotting has some limitations due to image resolution and/or printer quality.

181 Haug Andreas Aasen

Bø Skiskytterlag

Result: 8

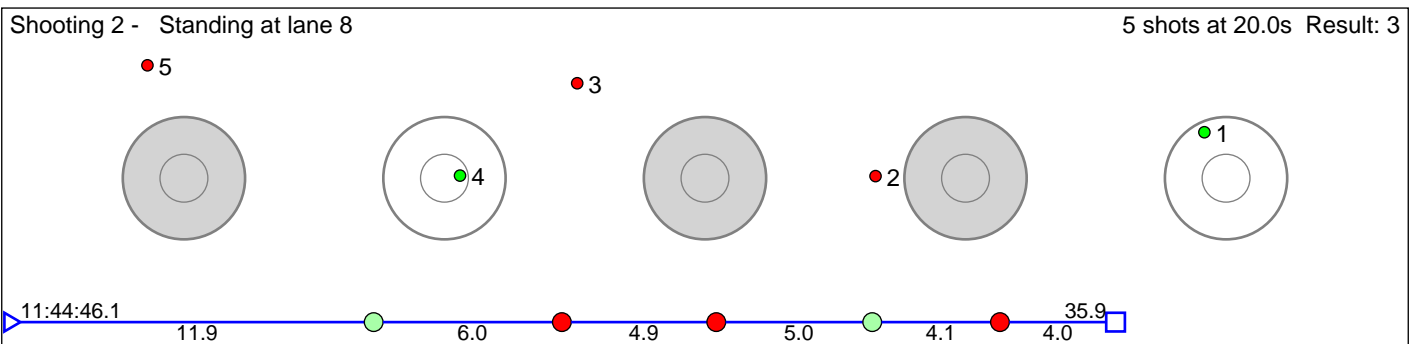
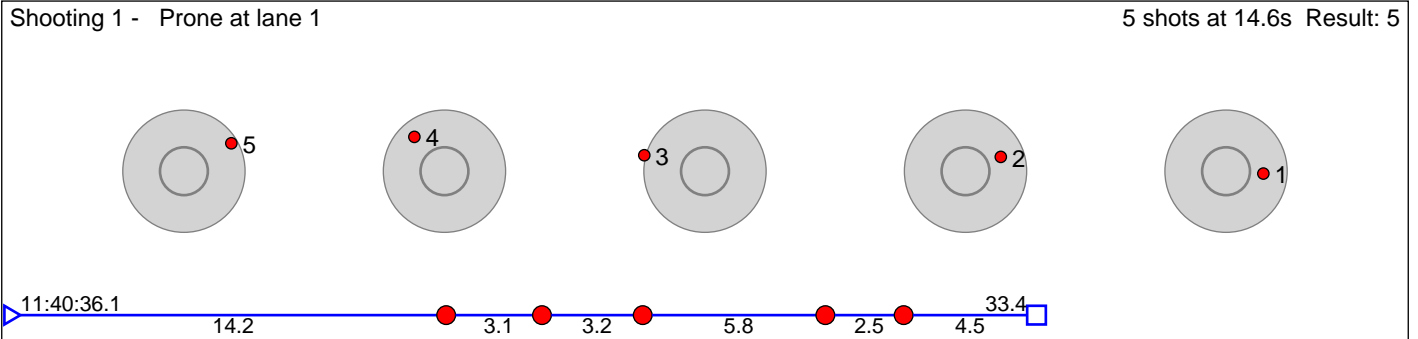

Disclaimer:

These results are unofficial since only the final output from the timing system can provide complete and correct competition results. The graphic plot of each series, presents the location of the shots on each of the five targets. Please observe that the accuracy of the plotting has some limitations due to image resolution and/or printer quality.

182 Walle Robert Ursin-Holm

Ivrig IL

Result: 4

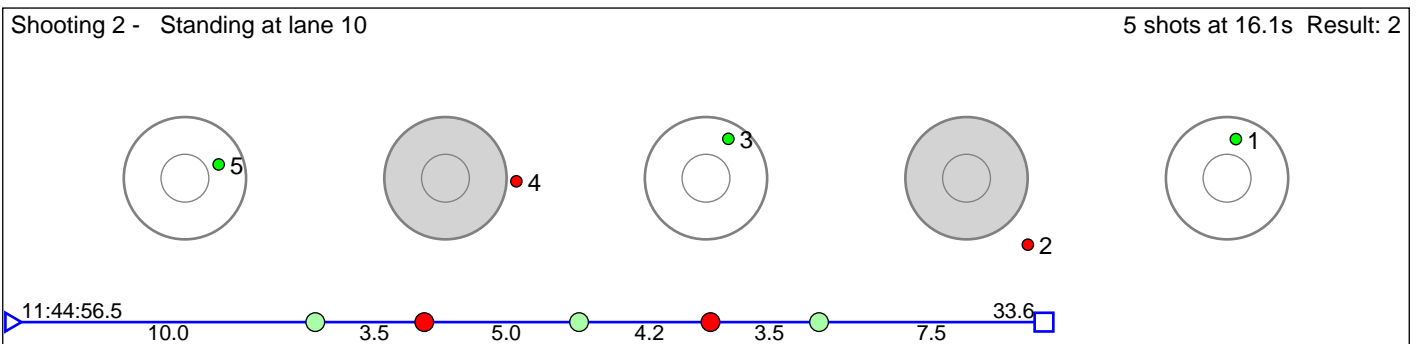
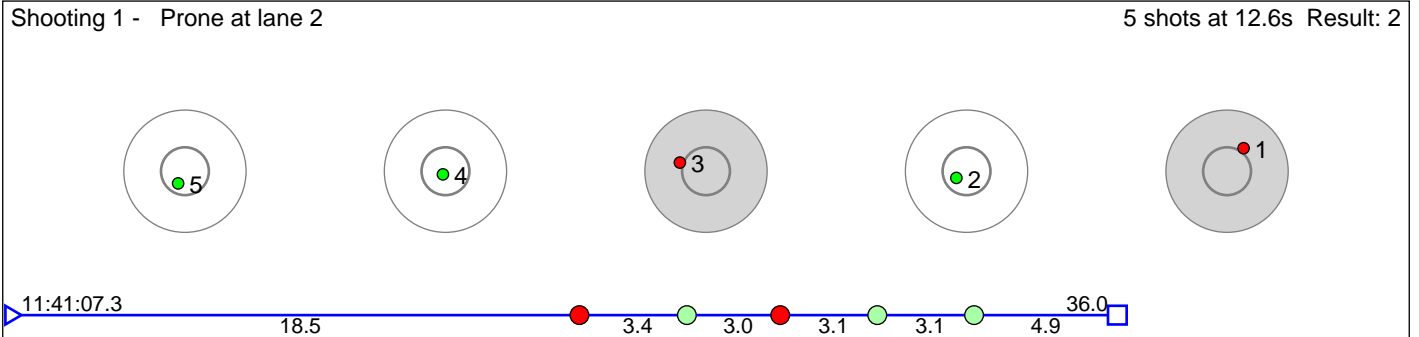

Disclaimer:

These results are unofficial since only the final output from the timing system can provide complete and correct competition results. The graphic plot of each series, presents the location of the shots on each of the five targets. Please observe that the accuracy of the plotting has some limitations due to image resolution and/or printer quality.

183 Lie Johannes Kolstad

Birkenes IL

Result: 5

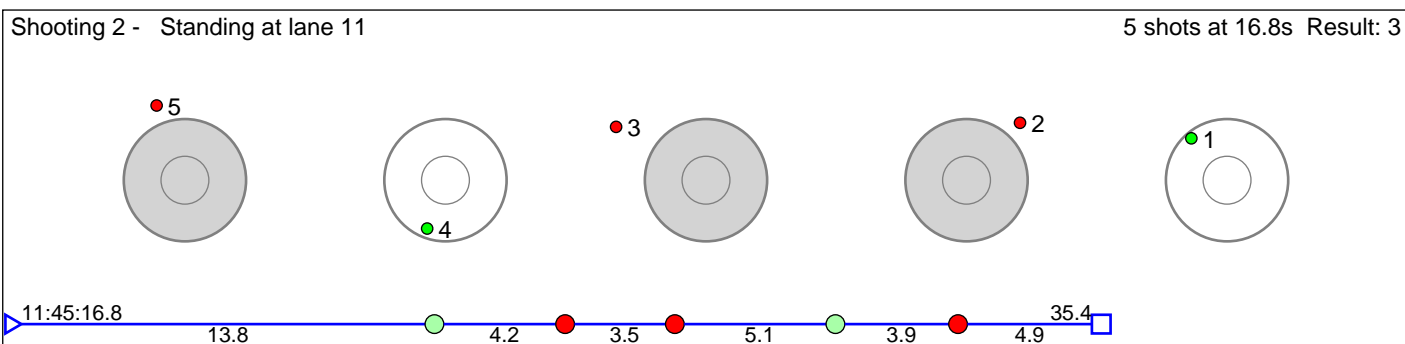
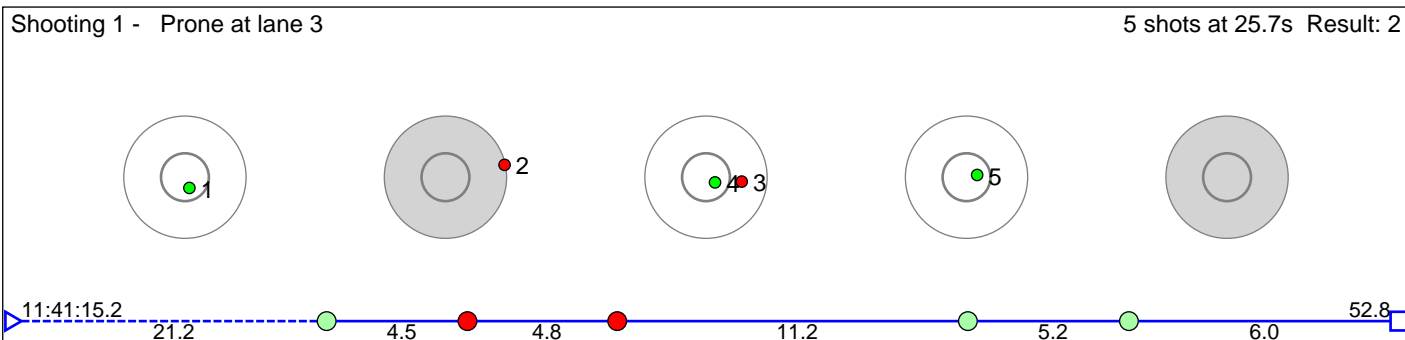

Disclaimer:

These results are unofficial since only the final output from the timing system can provide complete and correct competition results. The graphic plot of each series, presents the location of the shots on each of the five targets. Please observe that the accuracy of the plotting has some limitations due to image resolution and/or printer quality.

184 Ramsfjell William Brekken

Vingrom IL

Result: 4

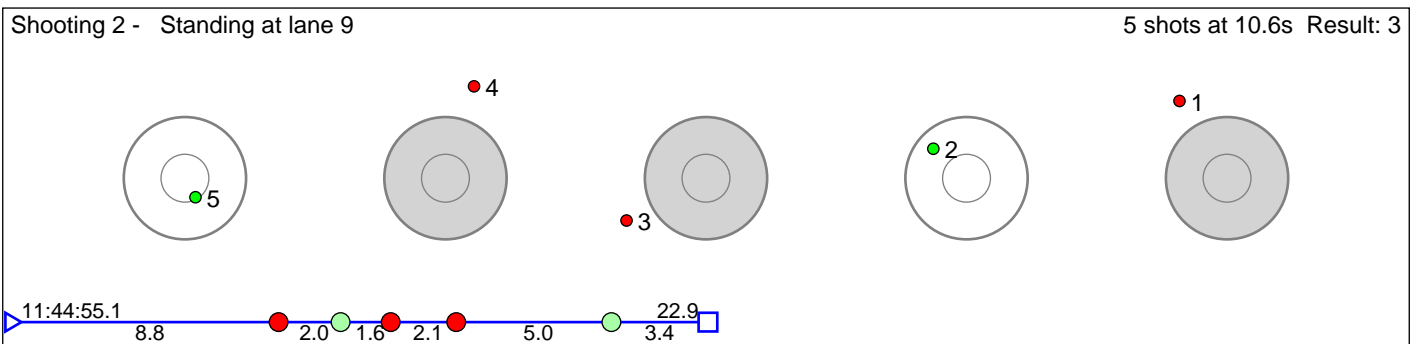
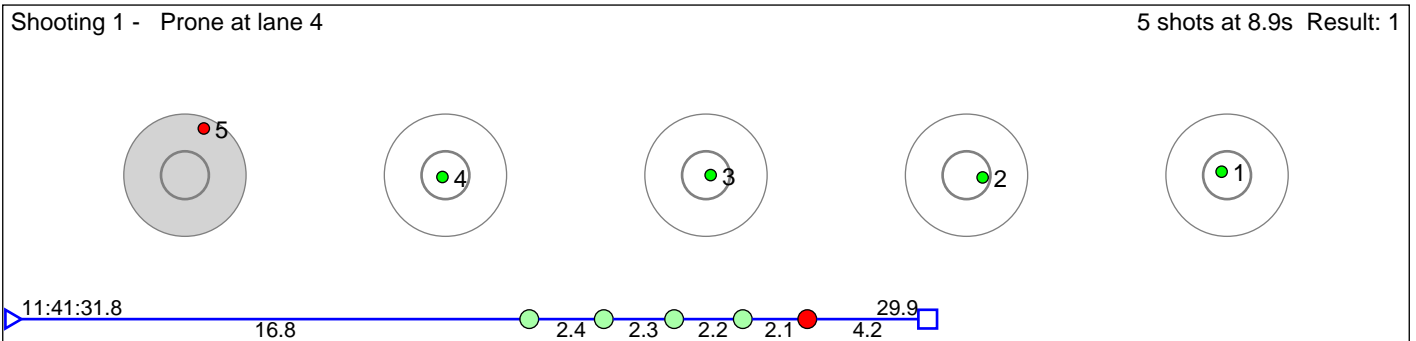

Disclaimer:

These results are unofficial since only the final output from the timing system can provide complete and correct competition results. The graphic plot of each series, presents the location of the shots on each of the five targets. Please observe that the accuracy of the plotting has some limitations due to image resolution and/or printer quality.

185 Søyby Sindre Andreas

Ivrig IL

Result: 5

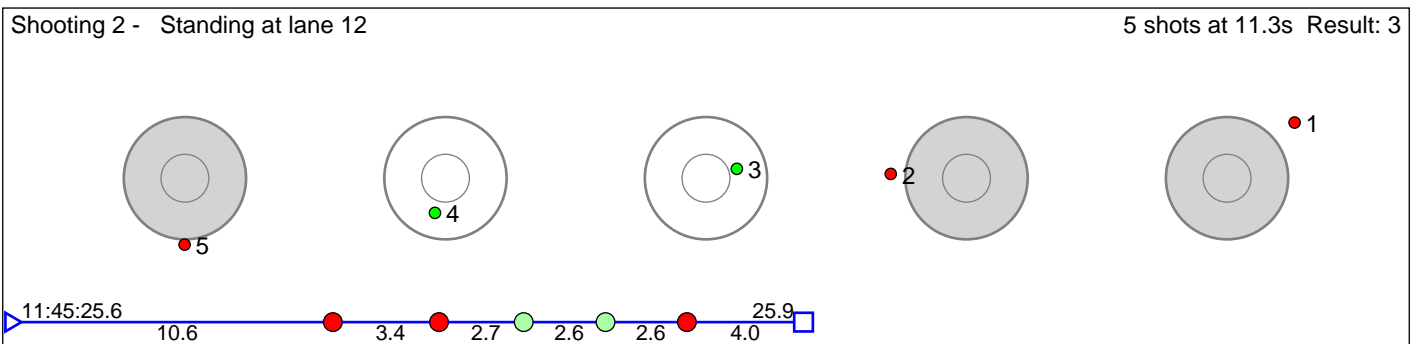
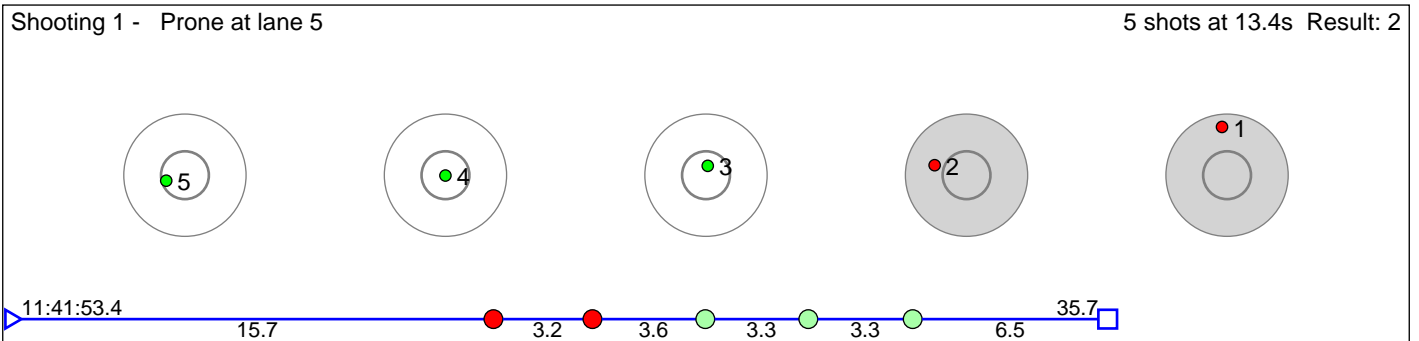

Disclaimer:

These results are unofficial since only the final output from the timing system can provide complete and correct competition results. The graphic plot of each series, presents the location of the shots on each of the five targets. Please observe that the accuracy of the plotting has some limitations due to image resolution and/or printer quality.

187 Berg Øystein Selstad

Asker Skiklubb

Result: 4

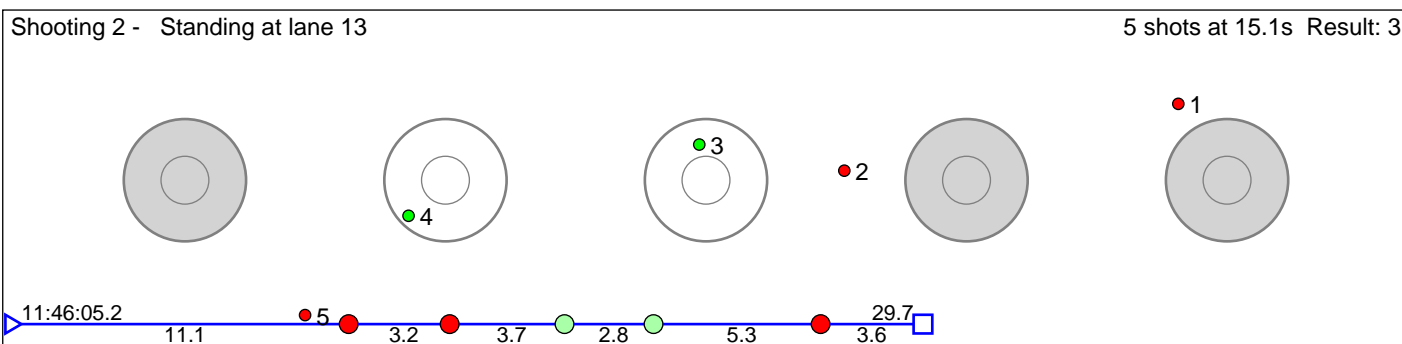
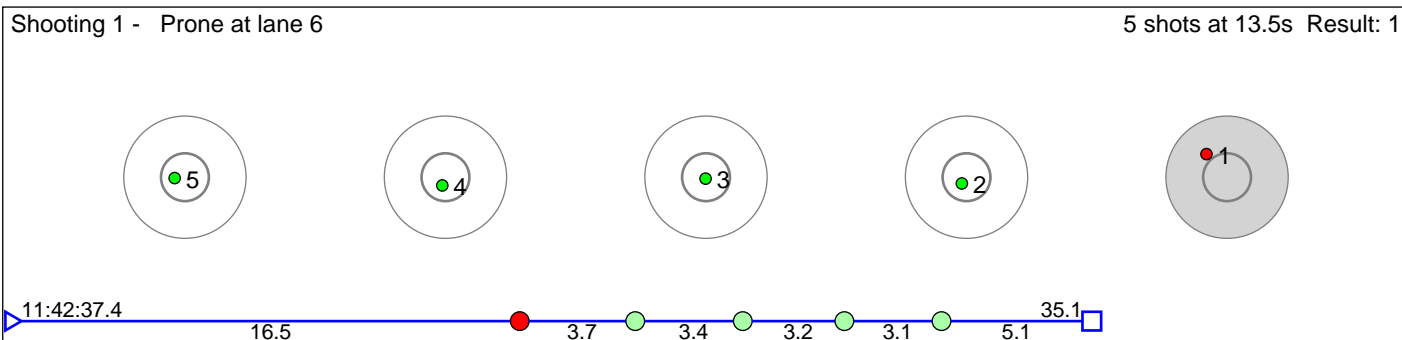

Disclaimer:

These results are unofficial since only the final output from the timing system can provide complete and correct competition results. The graphic plot of each series, presents the location of the shots on each of the five targets. Please observe that the accuracy of the plotting has some limitations due to image resolution and/or printer quality.

188 Håverstad Tobias Kerlefsen

Birkenes IL

Result: 4

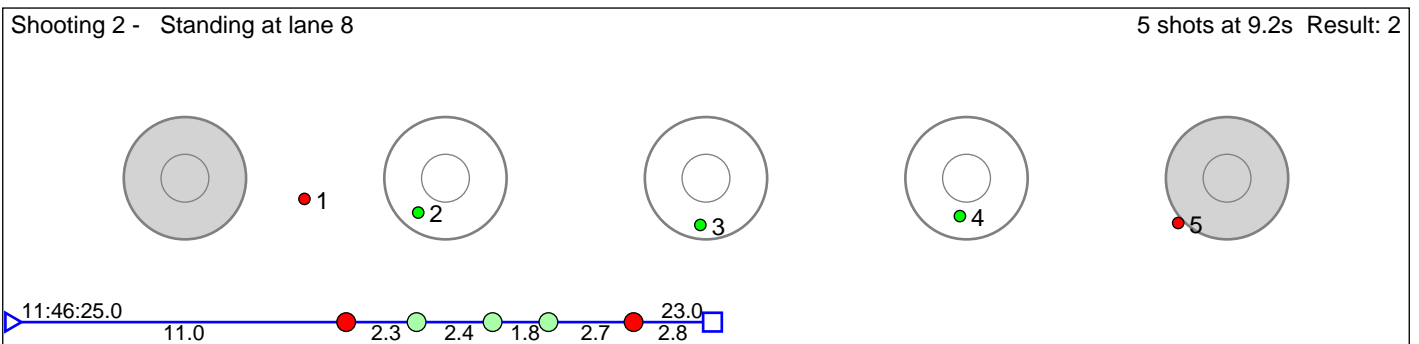
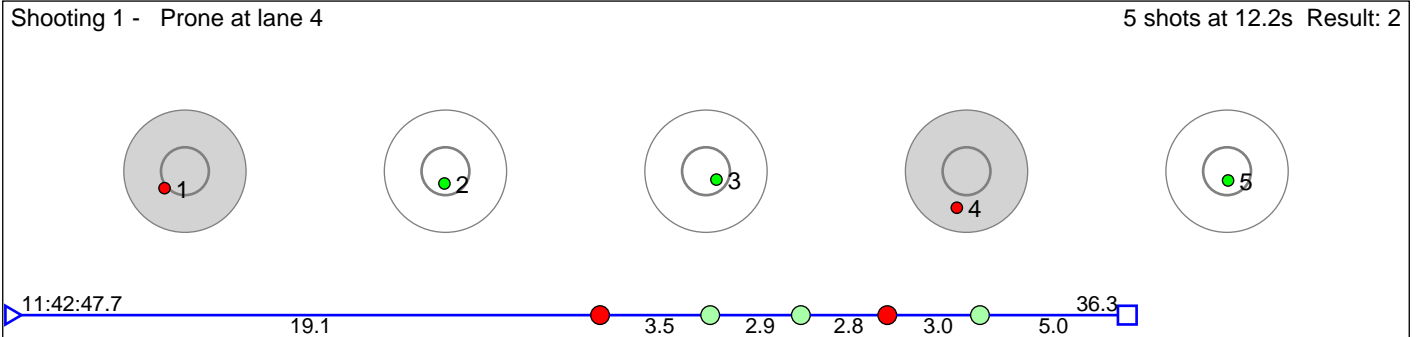

Disclaimer:

These results are unofficial since only the final output from the timing system can provide complete and correct competition results. The graphic plot of each series, presents the location of the shots on each of the five targets. Please observe that the accuracy of the plotting has some limitations due to image resolution and/or printer quality.

189 Hallingstad August

Bærums Skiklub

Result: 1

Shooting 1 - Prone at lane 1

5 shots at 8.1s Result: 1

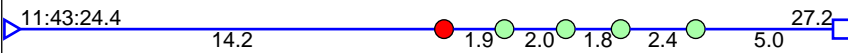
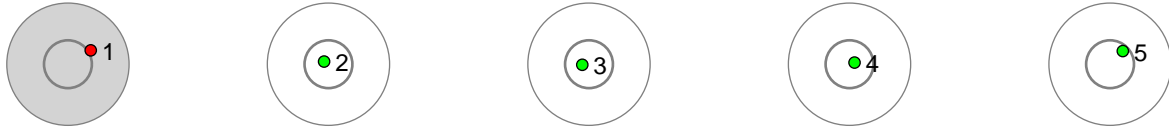

Shooting 2 - Standing at lane 9

5 shots at 13.8s Result: 0

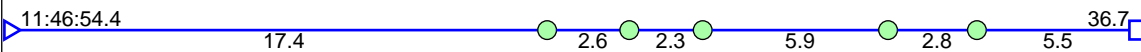
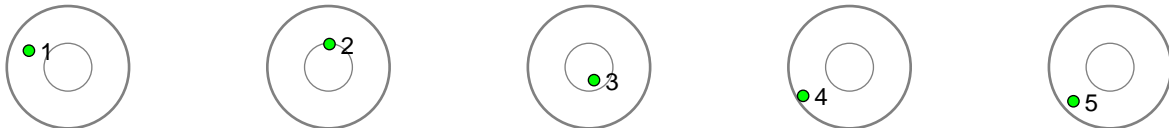

Disclaimer:

These results are unofficial since only the final output from the timing system can provide complete and correct competition results. The graphic plot of each series, presents the location of the shots on each of the five targets. Please observe that the accuracy of the plotting has some limitations due to image resolution and/or printer quality.

190 Aarhaug Jens Borgar

Sokna IL

Result: 4

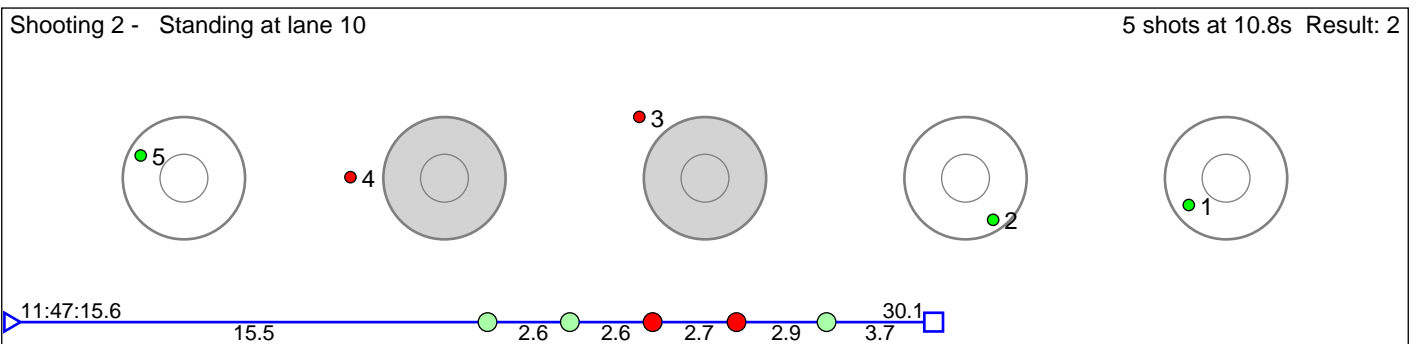
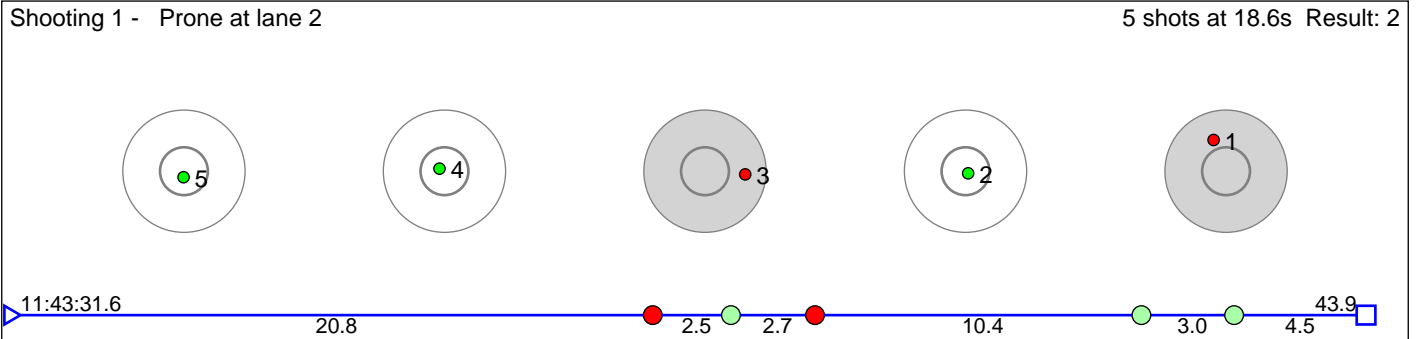

Disclaimer:

These results are unofficial since only the final output from the timing system can provide complete and correct competition results. The graphic plot of each series, presents the location of the shots on each of the five targets. Please observe that the accuracy of the plotting has some limitations due to image resolution and/or printer quality.

191 Smeland Nils Henrik

Birkenes IL

Result: 4

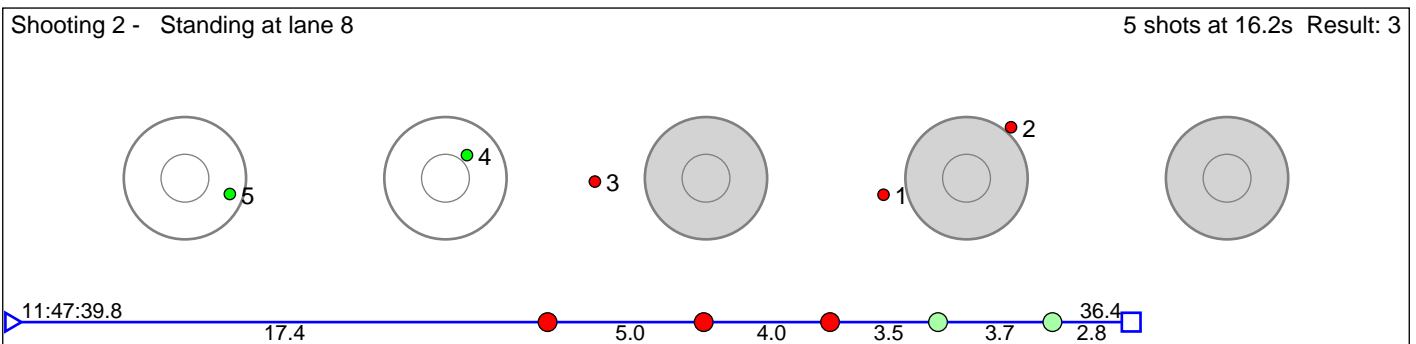
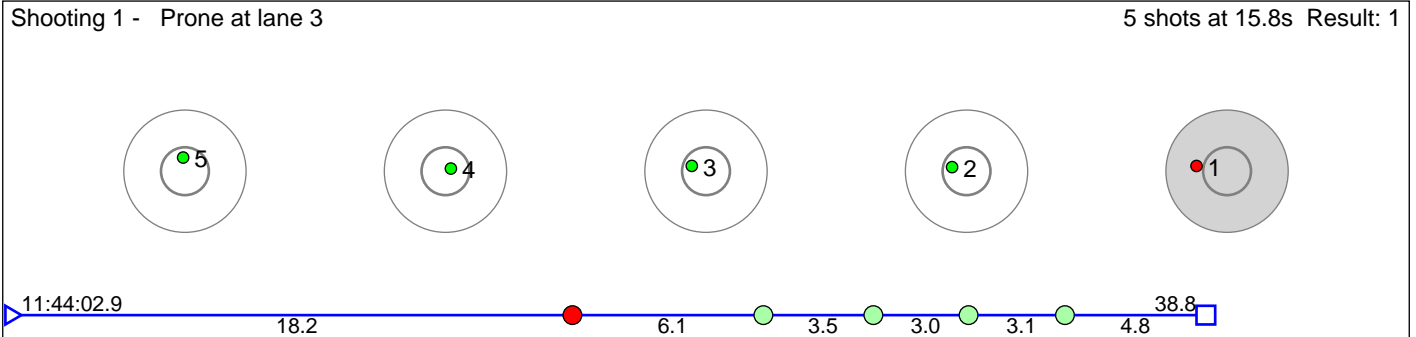

Disclaimer:

These results are unofficial since only the final output from the timing system can provide complete and correct competition results. The graphic plot of each series, presents the location of the shots on each of the five targets. Please observe that the accuracy of the plotting has some limitations due to image resolution and/or printer quality.

192 Gjerde Daniel Loga

Froland IL

Result: 3

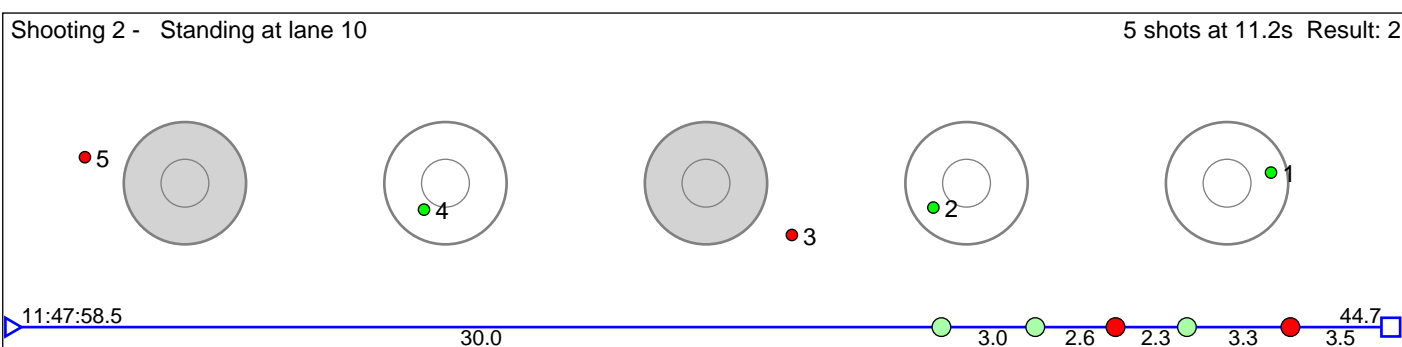
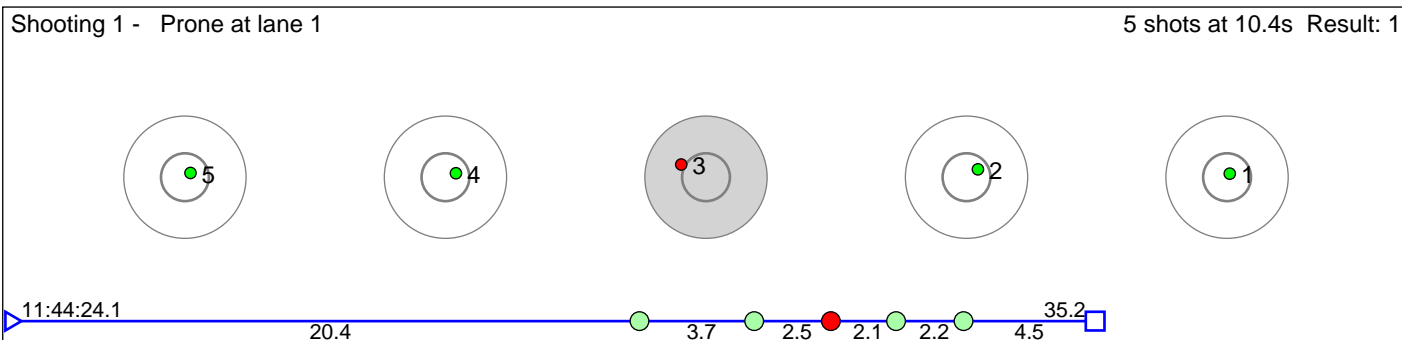

Disclaimer:

These results are unofficial since only the final output from the timing system can provide complete and correct competition results. The graphic plot of each series, presents the location of the shots on each of the five targets. Please observe that the accuracy of the plotting has some limitations due to image resolution and/or printer quality.

193 Bøylestad-Landa Olav

Froland IL

Result: 4

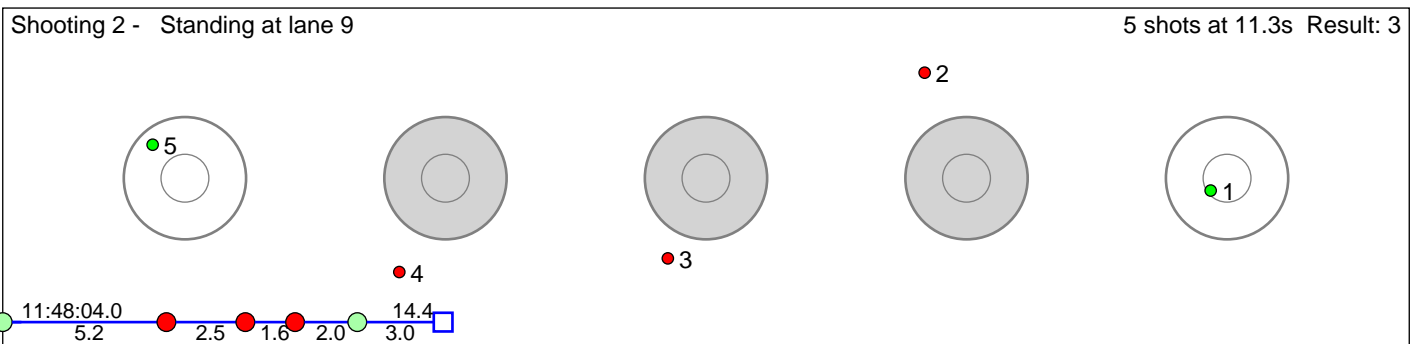
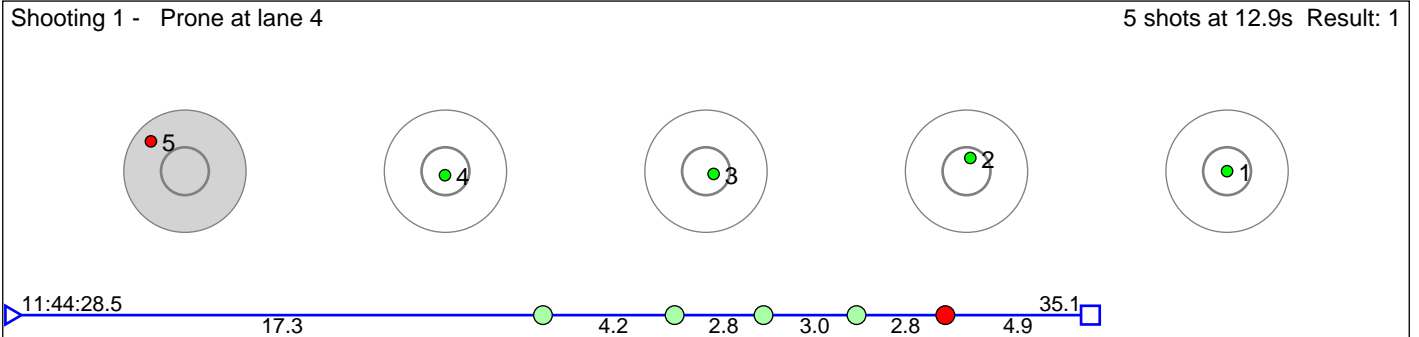

Disclaimer:

These results are unofficial since only the final output from the timing system can provide complete and correct competition results. The graphic plot of each series, presents the location of the shots on each of the five targets. Please observe that the accuracy of the plotting has some limitations due to image resolution and/or printer quality.

196 Berntsen Kaia Wulff

Asker Skiklubb

Result: 5

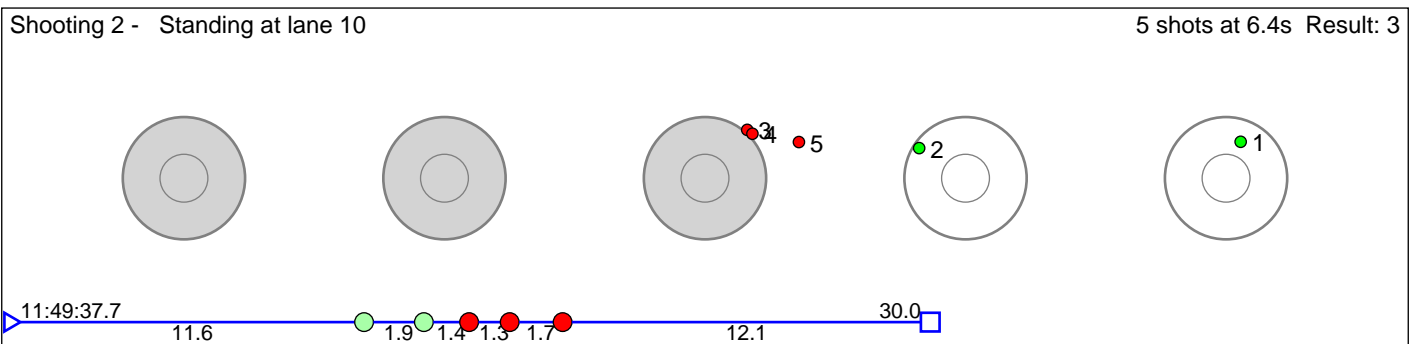
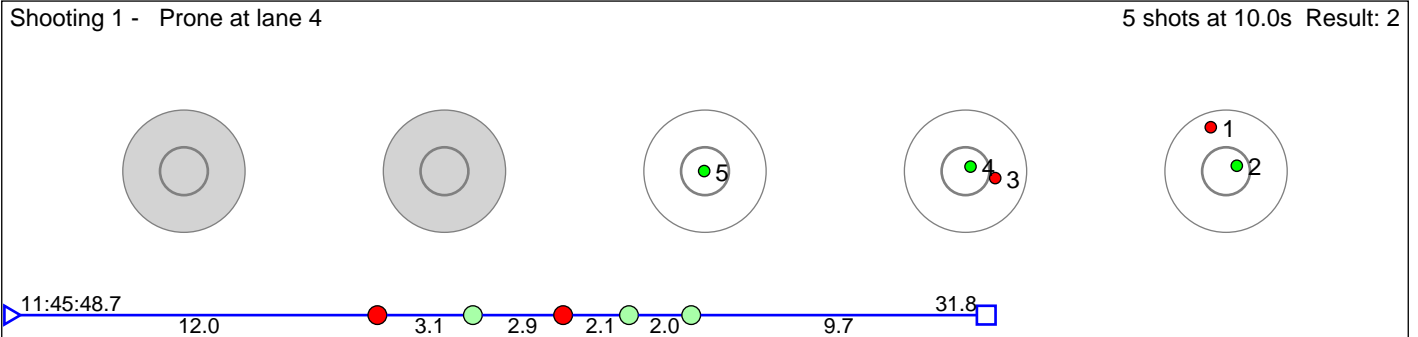

Disclaimer:

These results are unofficial since only the final output from the timing system can provide complete and correct competition results. The graphic plot of each series, presents the location of the shots on each of the five targets. Please observe that the accuracy of the plotting has some limitations due to image resolution and/or printer quality.

197 Gilbert-Jeanselme Lola

Result: 3

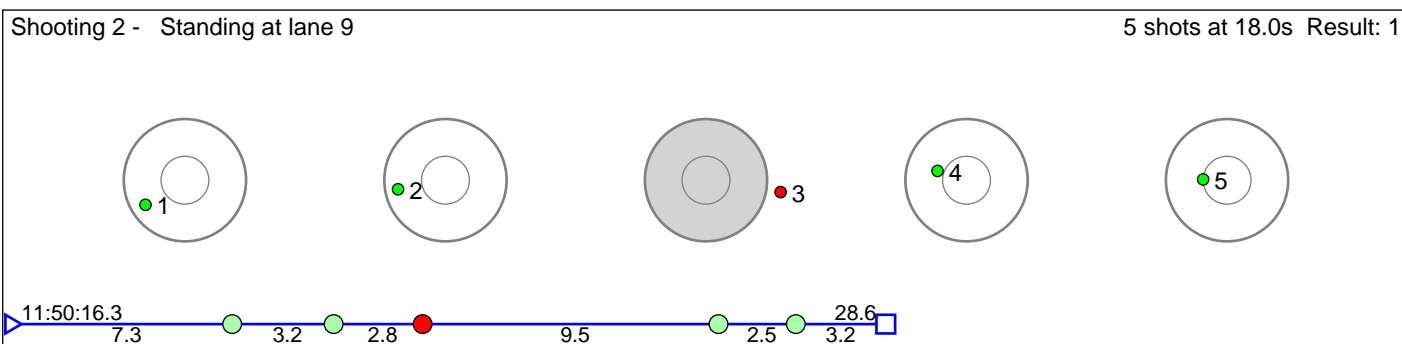
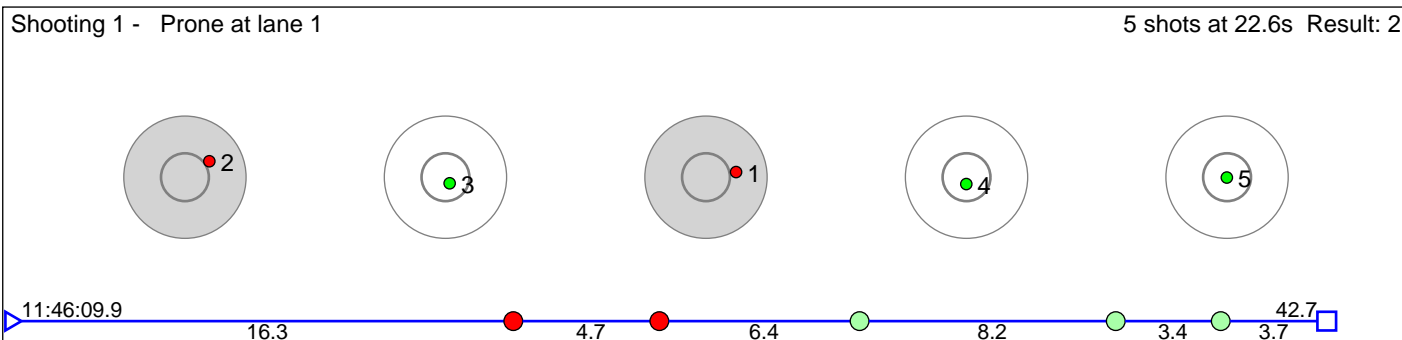

Disclaimer:

These results are unofficial since only the final output from the timing system can provide complete and correct competition results. The graphic plot of each series, presents the location of the shots on each of the five targets. Please observe that the accuracy of the plotting has some limitations due to image resolution and/or printer quality.

200 Tvinnereim Gunn Kristi Stensaker

Hardbagg IL

Result: 0

Shooting 1 - Prone at lane 2

5 shots at 11.4s Result: 0

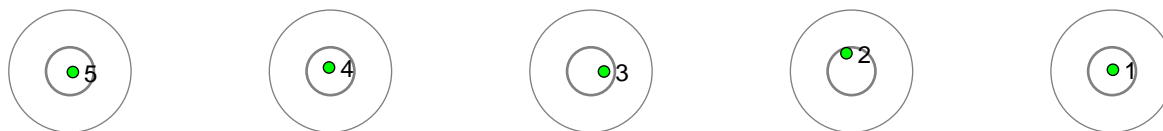

Shooting 2 - Standing at lane 10

5 shots at 12.3s Result: 0

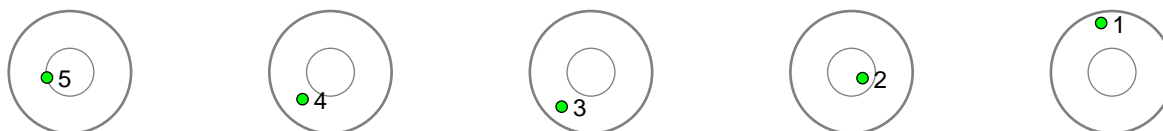

Disclaimer:

These results are unofficial since only the final output from the timing system can provide complete and correct competition results. The graphic plot of each series, presents the location of the shots on each of the five targets. Please observe that the accuracy of the plotting has some limitations due to image resolution and/or printer quality.

201 Jorde Tuva

Geilo IL

Result: 4

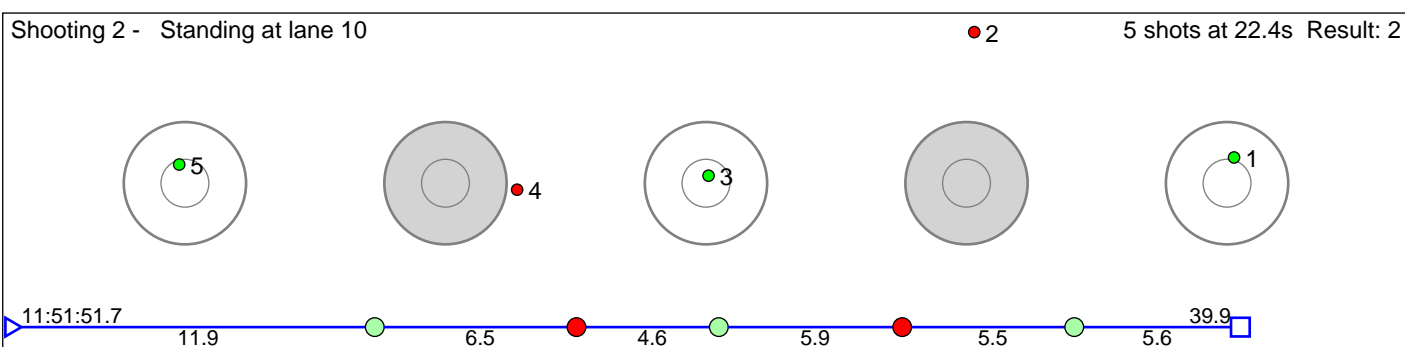
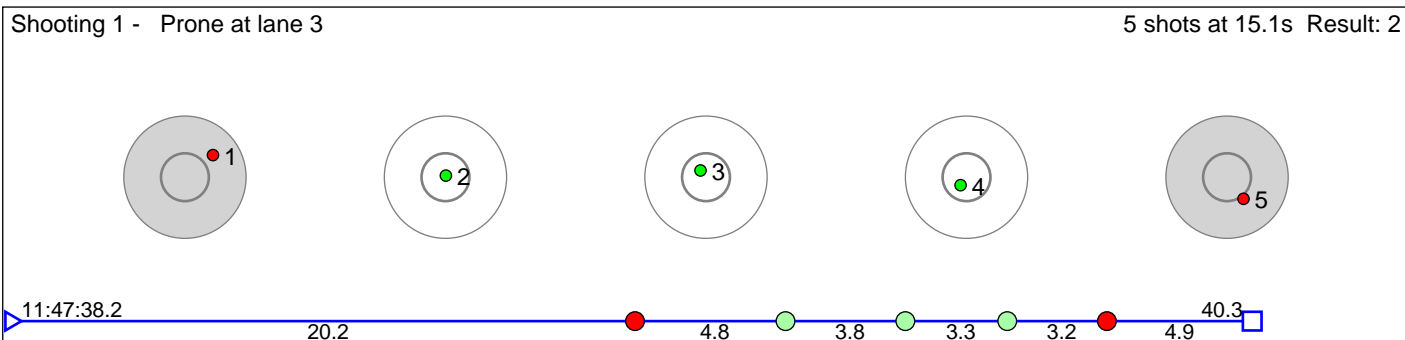

Disclaimer:

These results are unofficial since only the final output from the timing system can provide complete and correct competition results. The graphic plot of each series, presents the location of the shots on each of the five targets. Please observe that the accuracy of the plotting has some limitations due to image resolution and/or printer quality.

202 Fodstad Ragna

Østre Toten Skilag

Result: 4

Shooting 1 - Prone at lane 4

5 shots at 12.0s Result: 1

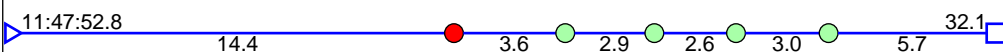
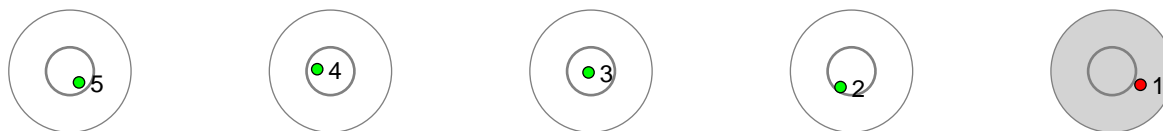

Shooting 2 - Standing at lane 9

5 shots at 9.8s Result: 3

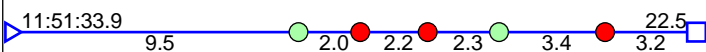
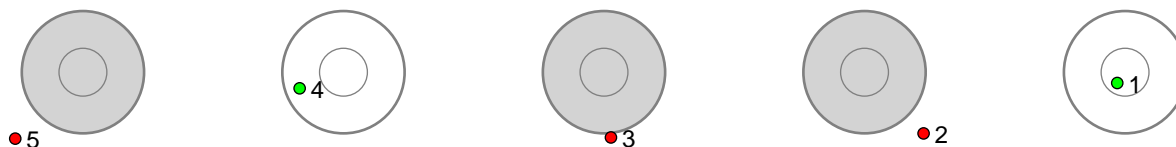

Disclaimer:

These results are unofficial since only the final output from the timing system can provide complete and correct competition results. The graphic plot of each series, presents the location of the shots on each of the five targets. Please observe that the accuracy of the plotting has some limitations due to image resolution and/or printer quality.

203 Groven Eira Reier

Drammen Strong

Result: 2

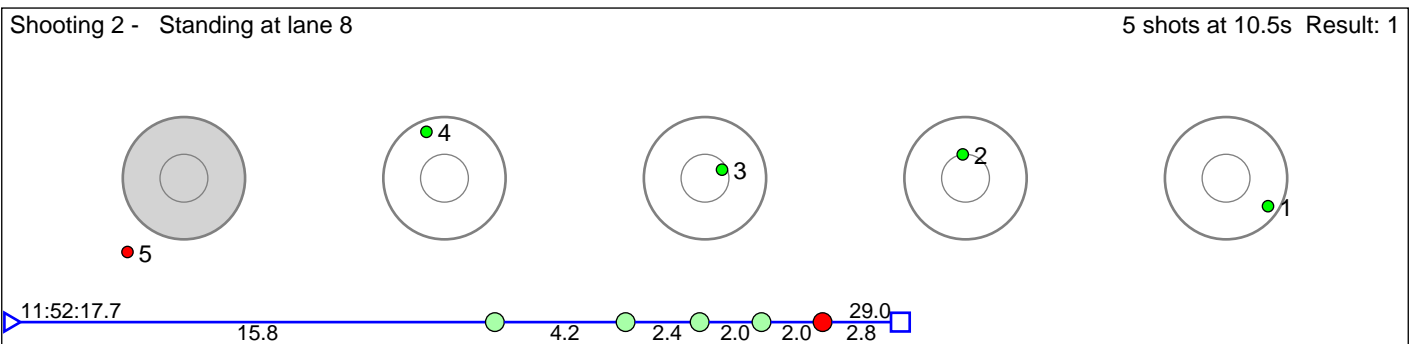
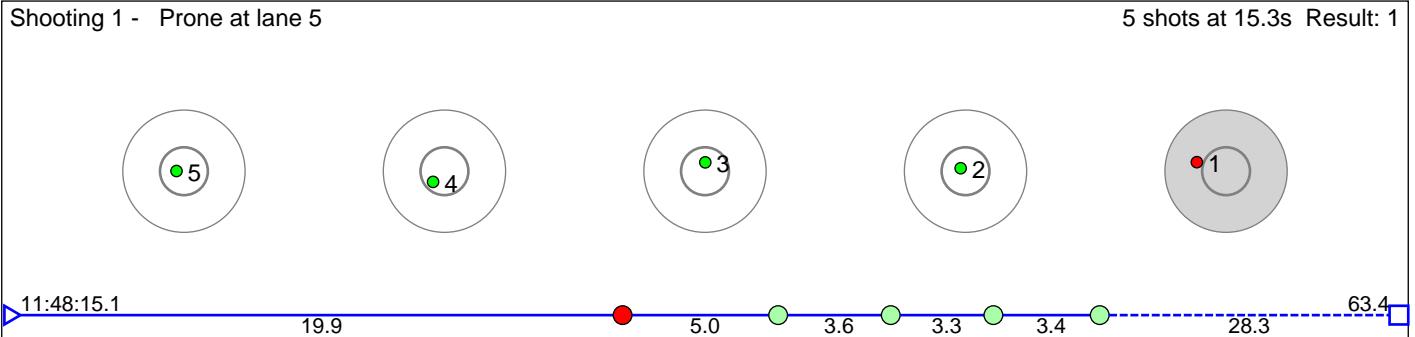

Disclaimer:

These results are unofficial since only the final output from the timing system can provide complete and correct competition results. The graphic plot of each series, presents the location of the shots on each of the five targets. Please observe that the accuracy of the plotting has some limitations due to image resolution and/or printer quality.

205 Rolstad Ingeborg Almeland

Oslo Skiskytterlag

Result: 2

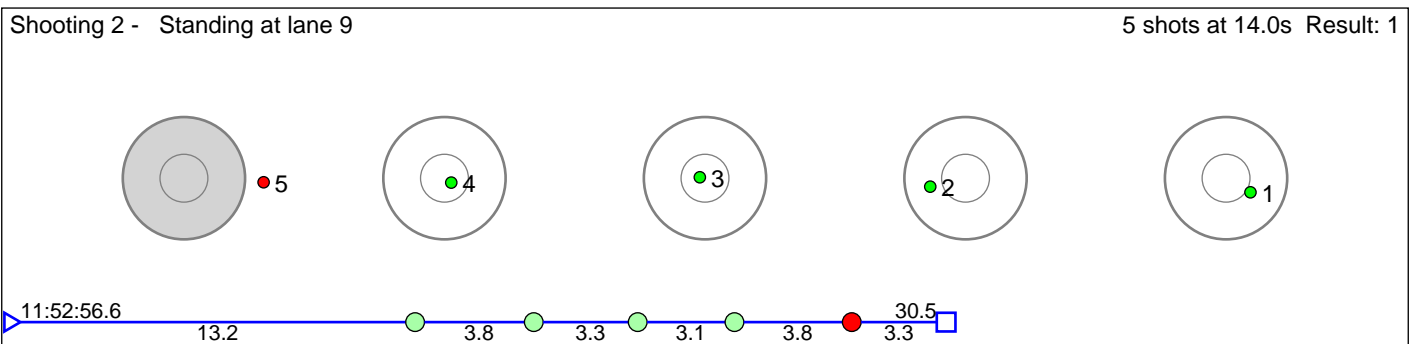
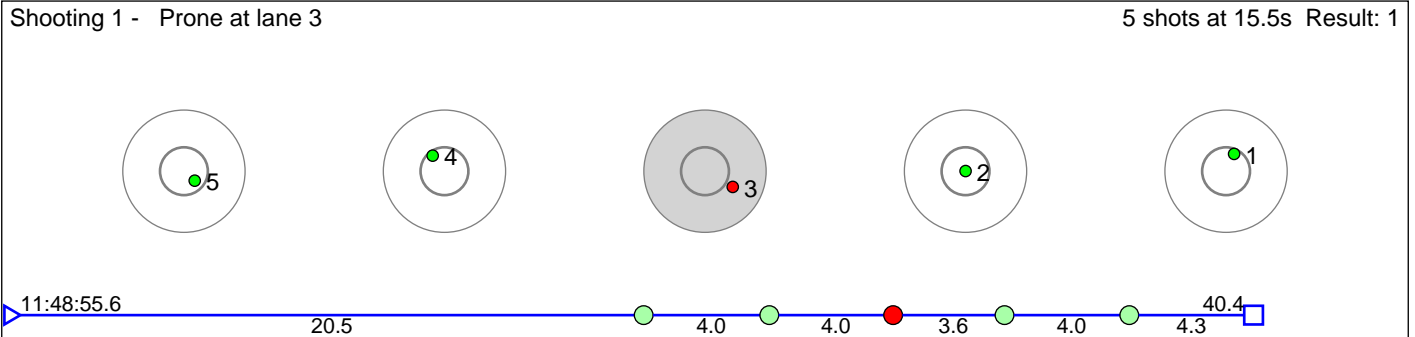

Disclaimer:

These results are unofficial since only the final output from the timing system can provide complete and correct competition results. The graphic plot of each series, presents the location of the shots on each of the five targets. Please observe that the accuracy of the plotting has some limitations due to image resolution and/or printer quality.

206 Østreng Mia Jenny Nygaard

Gjerdrum IL

Result: 4

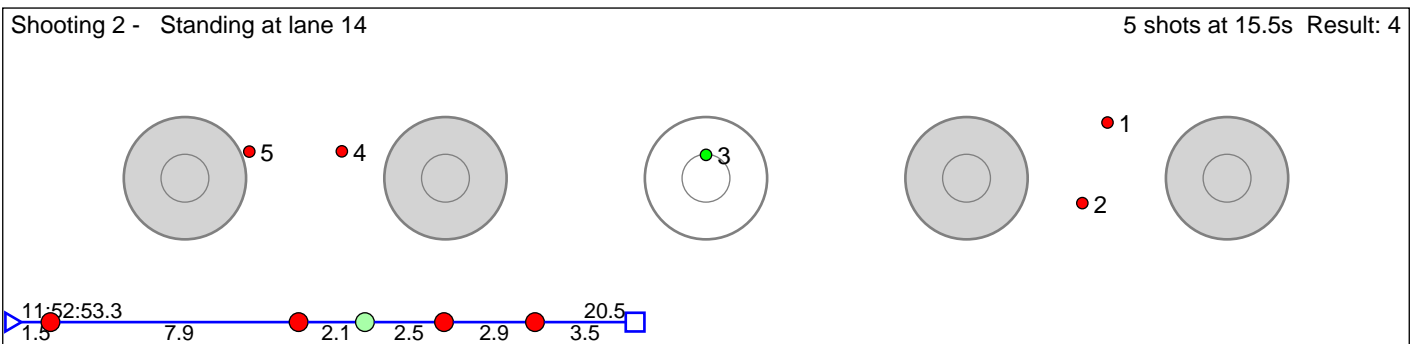
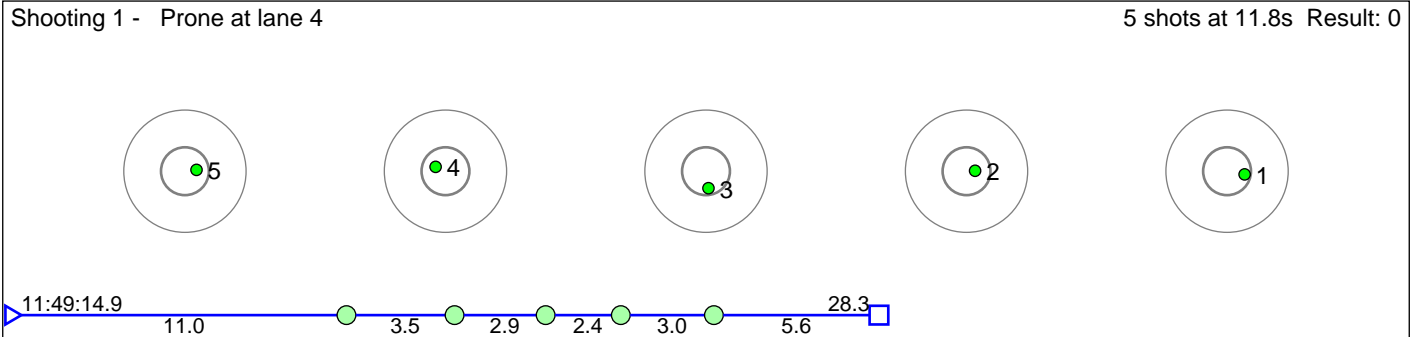

Disclaimer:

These results are unofficial since only the final output from the timing system can provide complete and correct competition results. The graphic plot of each series, presents the location of the shots on each of the five targets. Please observe that the accuracy of the plotting has some limitations due to image resolution and/or printer quality.

207 Tveito Tonje

Ål Skiskyttarlag

Result: 3

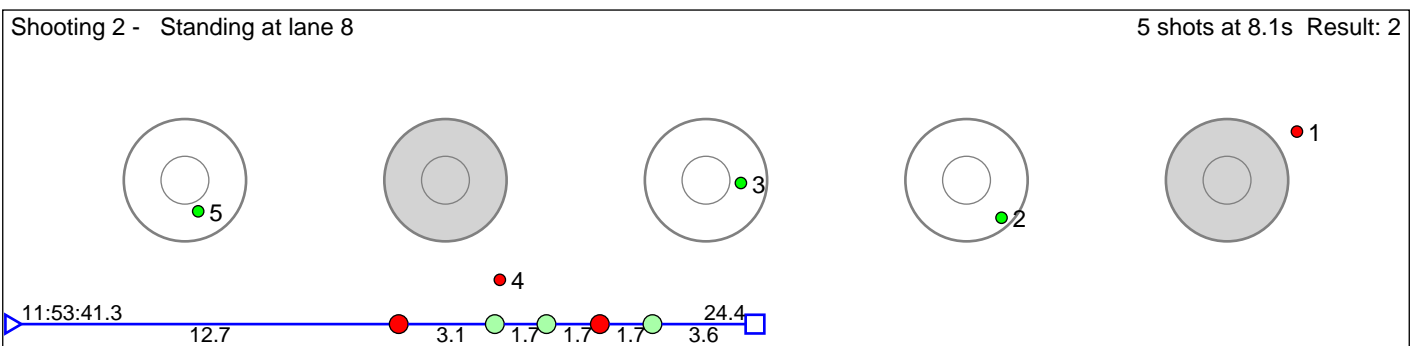
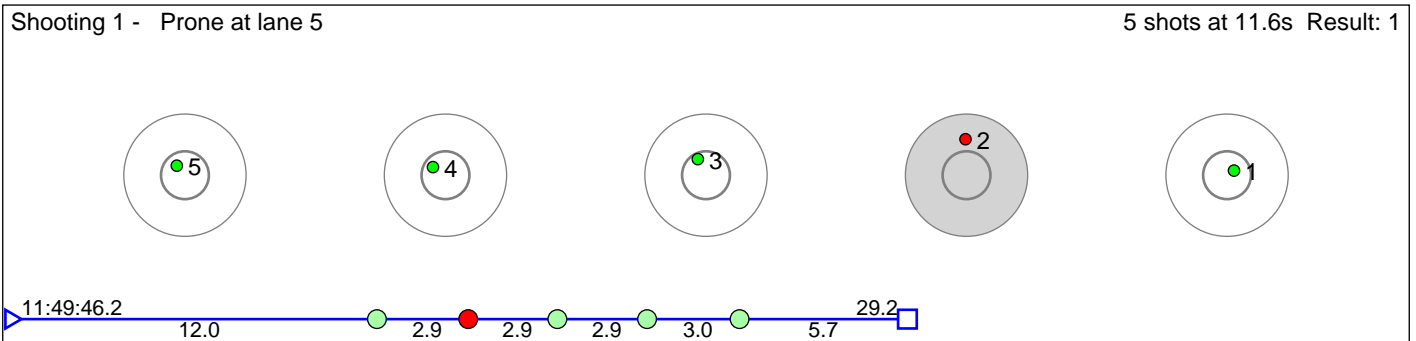

Disclaimer:

These results are unofficial since only the final output from the timing system can provide complete and correct competition results. The graphic plot of each series, presents the location of the shots on each of the five targets. Please observe that the accuracy of the plotting has some limitations due to image resolution and/or printer quality.

208 Volden Nora Flotten

Oppdal IL

Result: 4

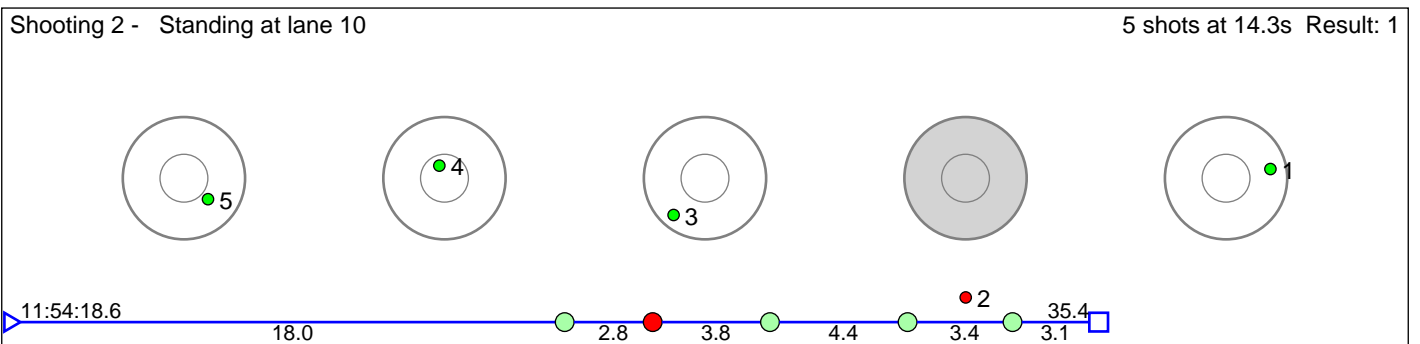
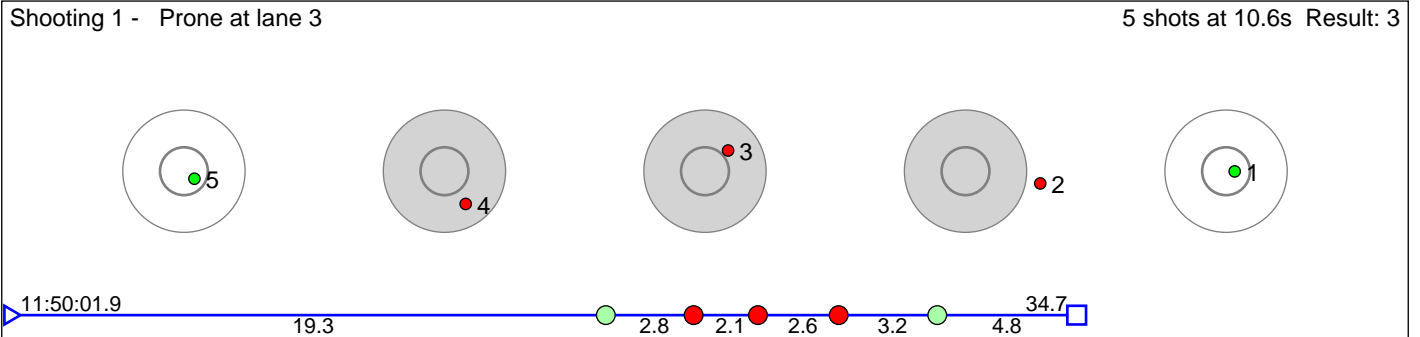

Disclaimer:

These results are unofficial since only the final output from the timing system can provide complete and correct competition results. The graphic plot of each series, presents the location of the shots on each of the five targets. Please observe that the accuracy of the plotting has some limitations due to image resolution and/or printer quality.

211 Femsteinevik Guro

Hålandsdal IL

Result: 4

Shooting 1 - Prone at lane 5

5 shots at 14.9s Result: 2

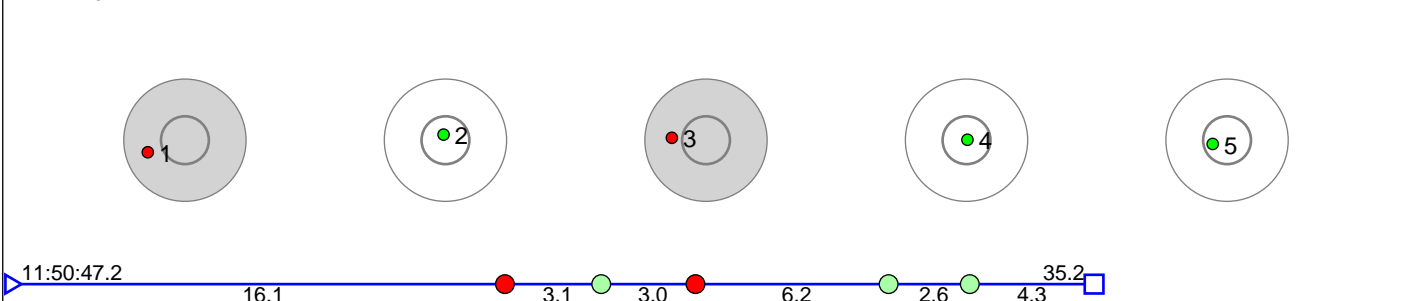

Shooting 2 - Standing at lane 11

5 shots at 12.3s Result: 2

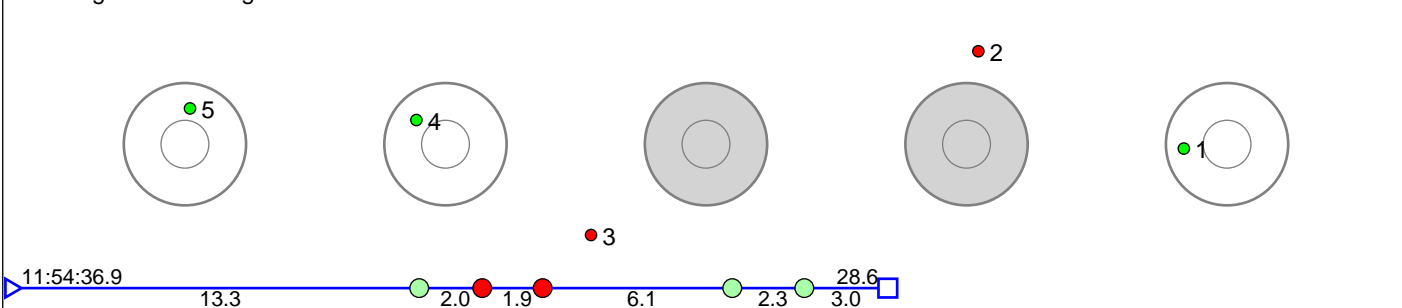

Disclaimer:

These results are unofficial since only the final output from the timing system can provide complete and correct competition results. The graphic plot of each series, presents the location of the shots on each of the five targets. Please observe that the accuracy of the plotting has some limitations due to image resolution and/or printer quality.

212 Radkovska Lora Georgieva

Result: 6

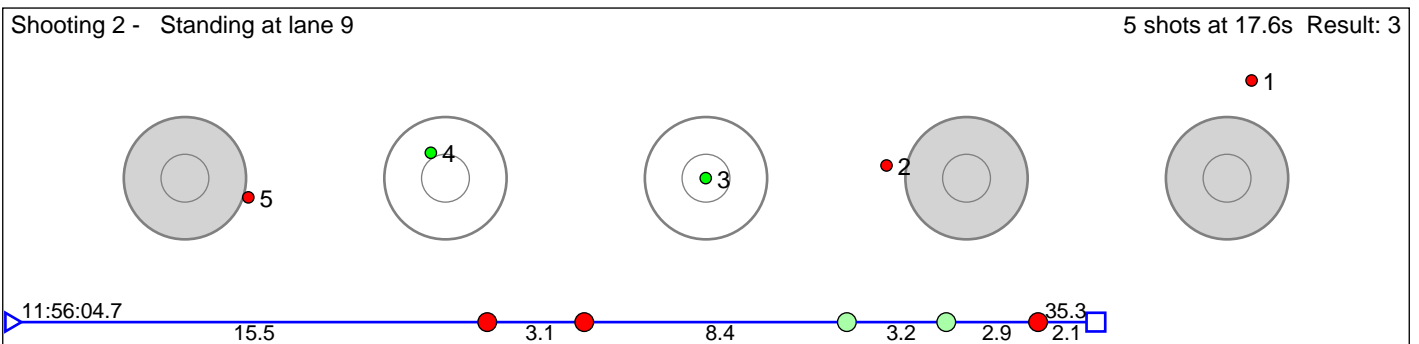
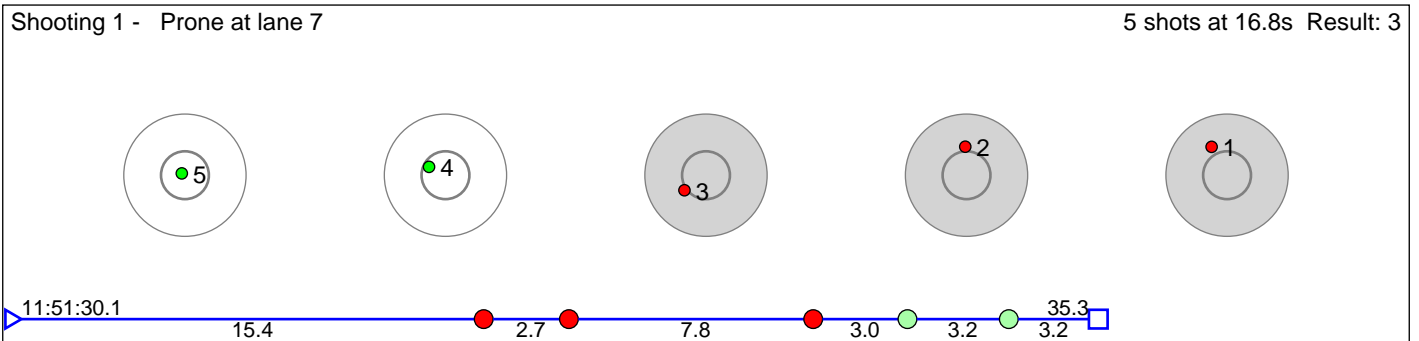

Disclaimer:

These results are unofficial since only the final output from the timing system can provide complete and correct competition results. The graphic plot of each series, presents the location of the shots on each of the five targets. Please observe that the accuracy of the plotting has some limitations due to image resolution and/or printer quality.

213 Rolstad Kristiane Almeland

Oslo Skiskytterlag

Result: 5

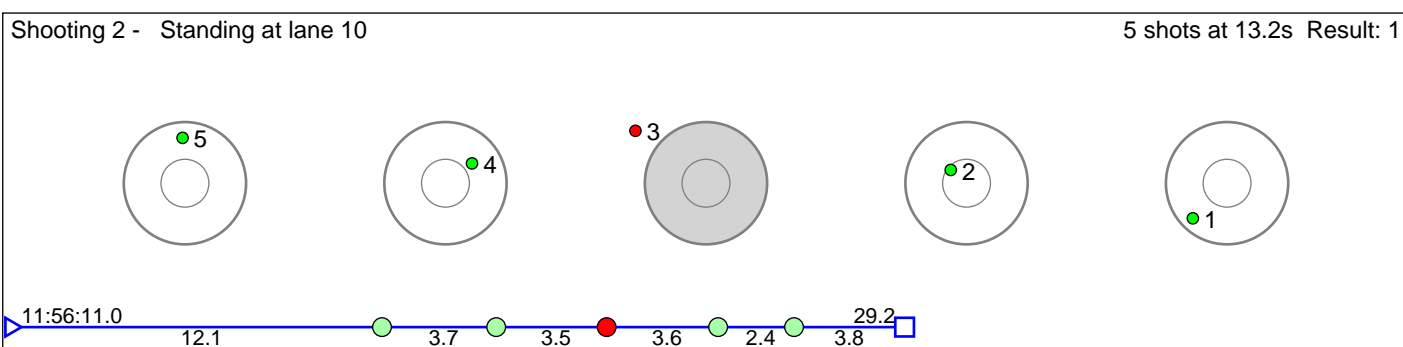
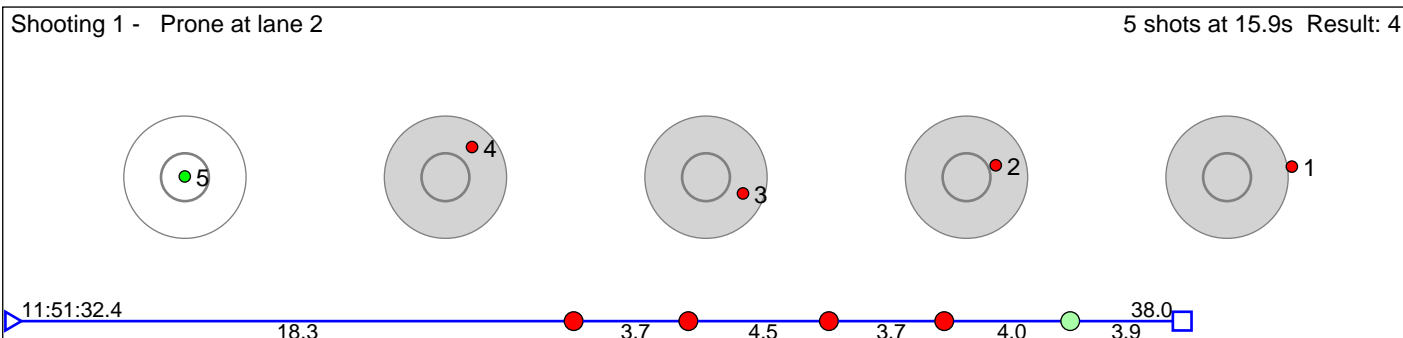

Disclaimer:

These results are unofficial since only the final output from the timing system can provide complete and correct competition results. The graphic plot of each series, presents the location of the shots on each of the five targets. Please observe that the accuracy of the plotting has some limitations due to image resolution and/or printer quality.

214 Torsteinsrud Gro

Ål Skiskyttarlag

Result: 6

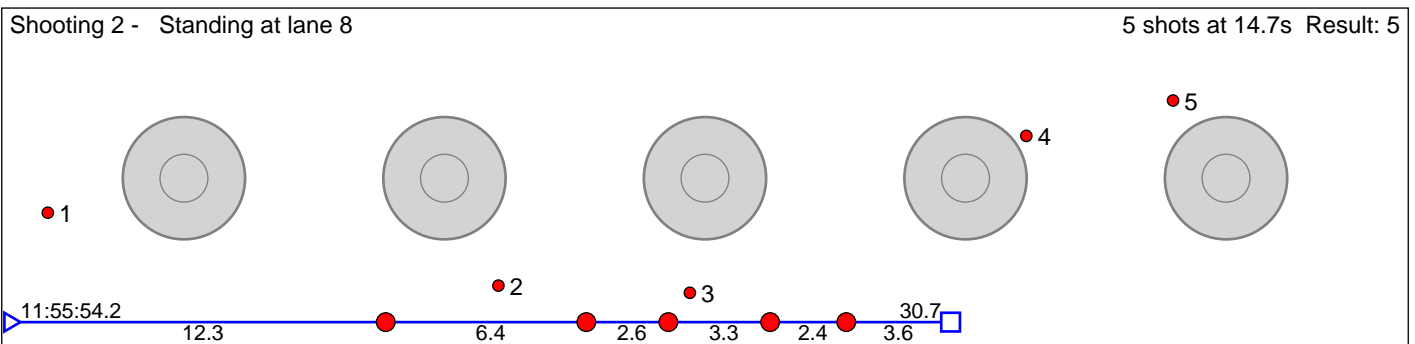
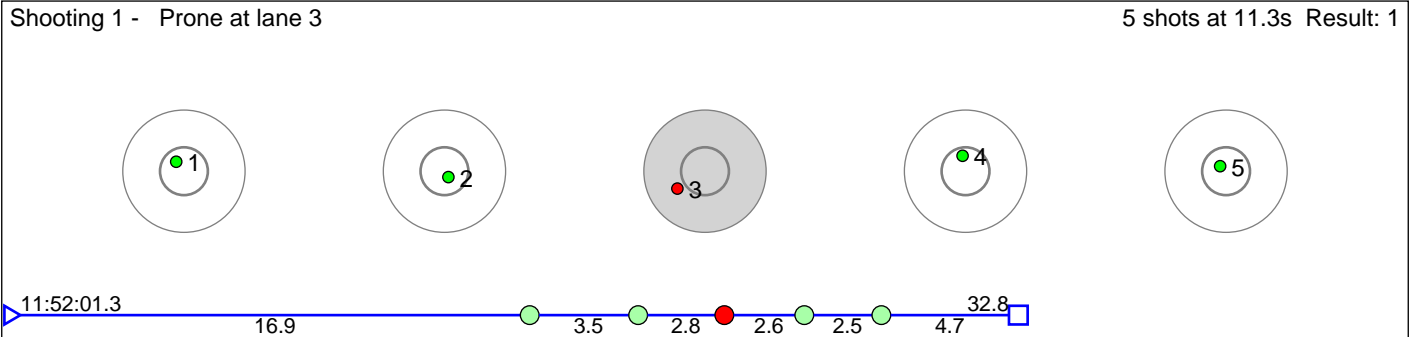

Disclaimer:

These results are unofficial since only the final output from the timing system can provide complete and correct competition results. The graphic plot of each series, presents the location of the shots on each of the five targets. Please observe that the accuracy of the plotting has some limitations due to image resolution and/or printer quality.

215 Brännare-Gran Maren Sofie

Bærums Skiklub

Result: 5

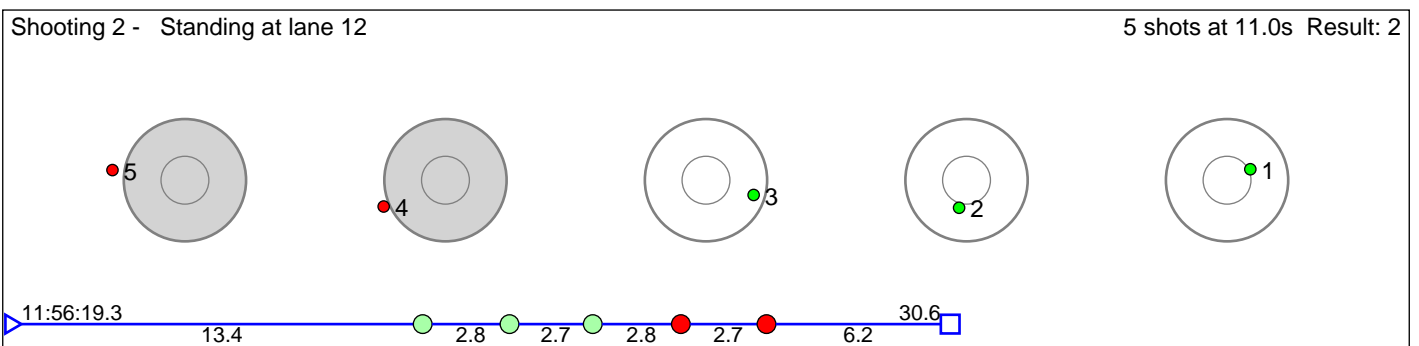
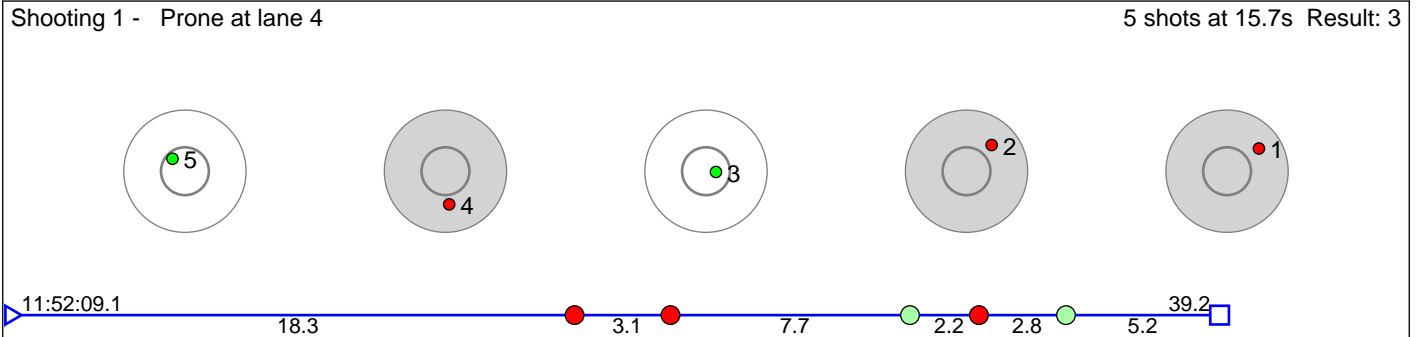

Disclaimer:

These results are unofficial since only the final output from the timing system can provide complete and correct competition results. The graphic plot of each series, presents the location of the shots on each of the five targets. Please observe that the accuracy of the plotting has some limitations due to image resolution and/or printer quality.

216 Elvestad Mari Haugenes

Bø Skiskytterlag

Result: 4

Shooting 1 - Prone at lane 5

5 shots at 13.6s Result: 1

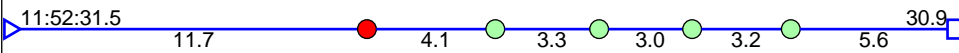
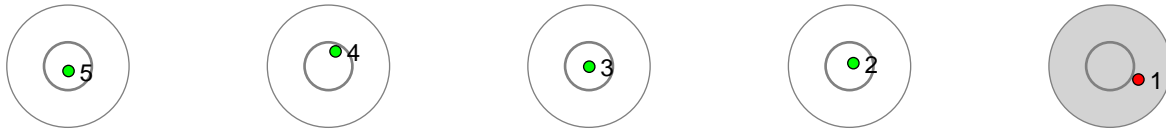

Shooting 2 - Standing at lane 11

5 shots at 10.3s Result: 3

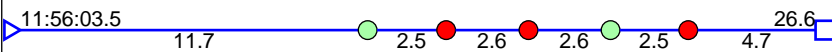
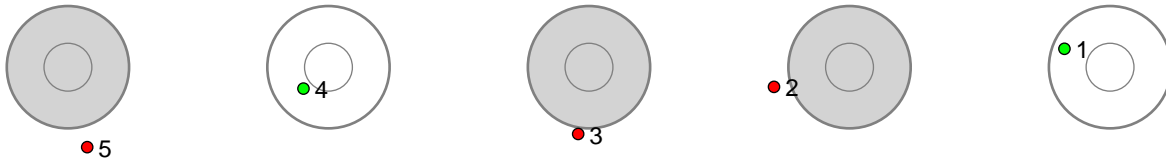

Disclaimer:

These results are unofficial since only the final output from the timing system can provide complete and correct competition results. The graphic plot of each series, presents the location of the shots on each of the five targets. Please observe that the accuracy of the plotting has some limitations due to image resolution and/or printer quality.

218 Bjørndalen Sivert

Simostranda IL

Result: 7

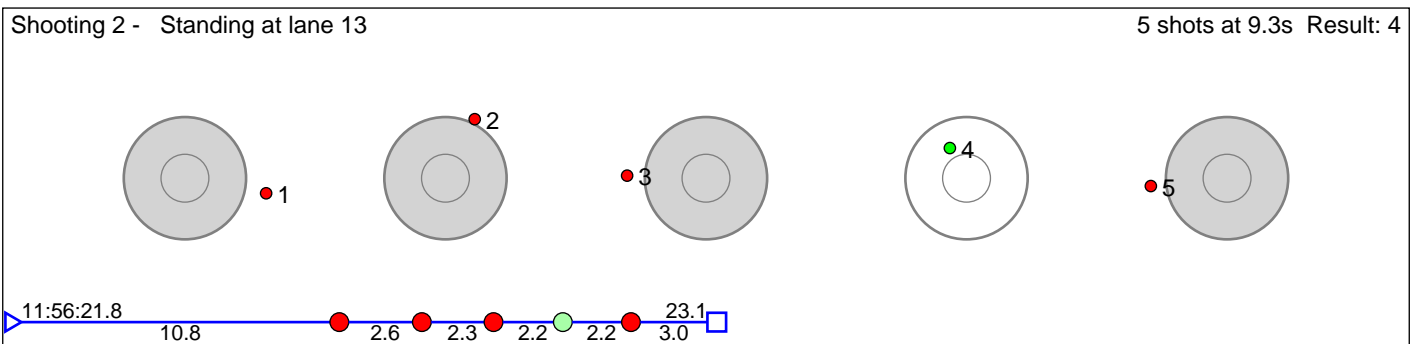
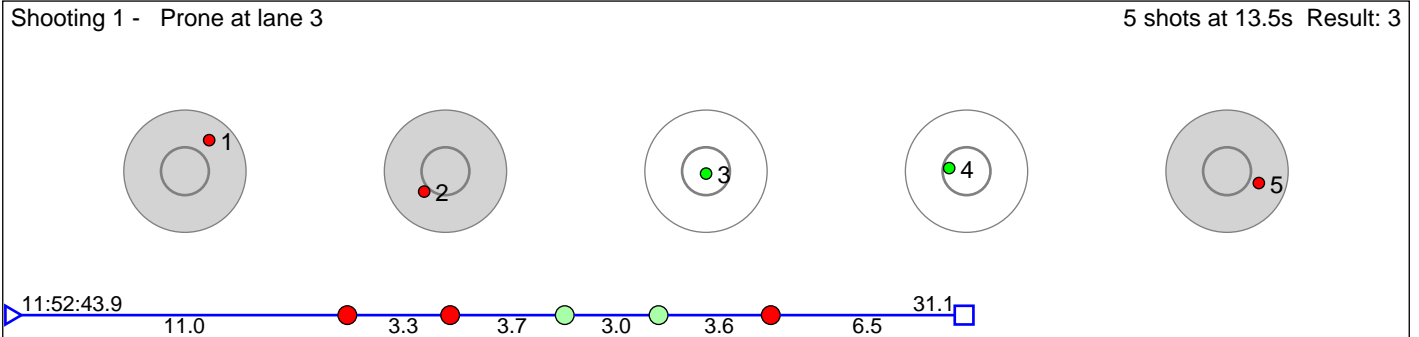

Disclaimer:

These results are unofficial since only the final output from the timing system can provide complete and correct competition results. The graphic plot of each series, presents the location of the shots on each of the five targets. Please observe that the accuracy of the plotting has some limitations due to image resolution and/or printer quality.

222 Visser Jon Einar Mattias

Meråker Skiskytterklubb

Result: 5

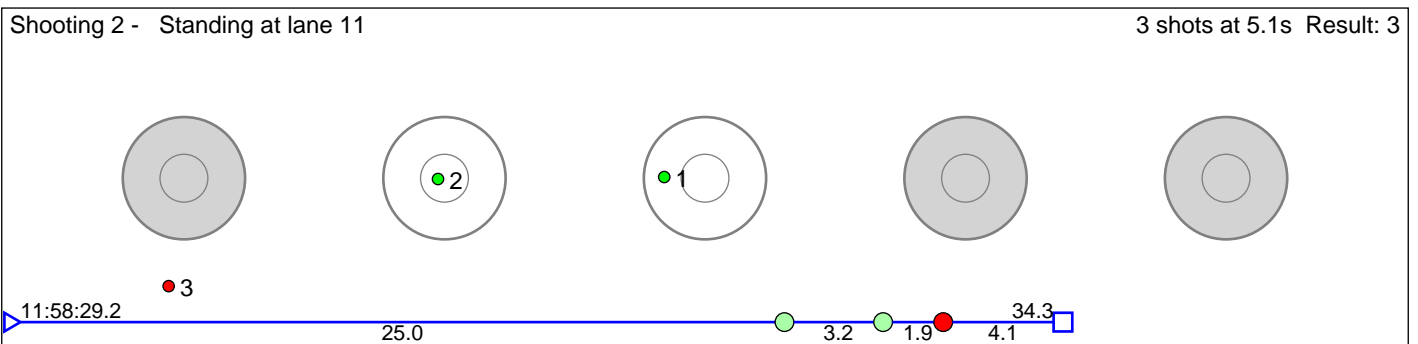
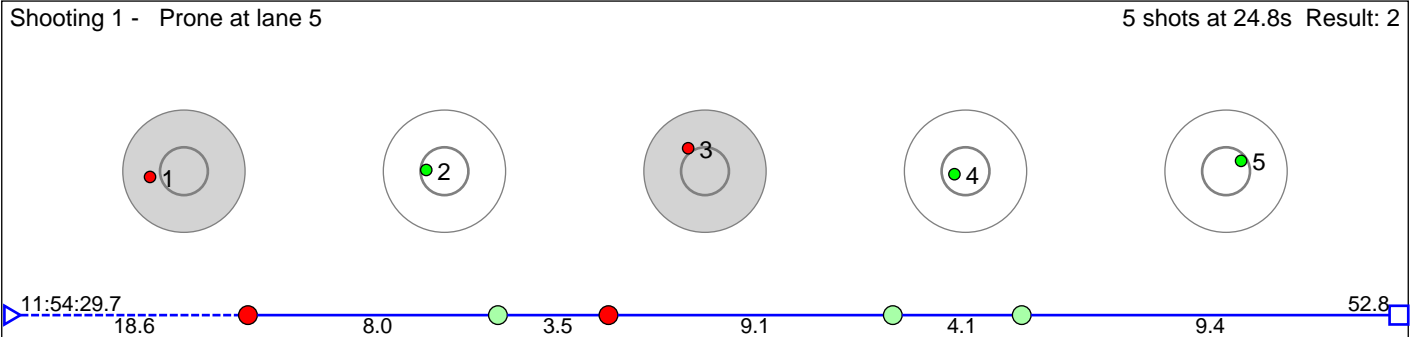

Disclaimer:

These results are unofficial since only the final output from the timing system can provide complete and correct competition results. The graphic plot of each series, presents the location of the shots on each of the five targets. Please observe that the accuracy of the plotting has some limitations due to image resolution and/or printer quality.

223 Halvorsen Øyvind Henanger

Hålandsdal IL

Result: 4

Shooting 1 - Prone at lane 6

5 shots at 11.8s Result: 2

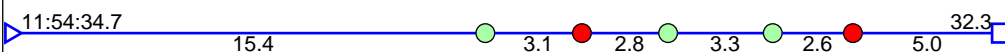
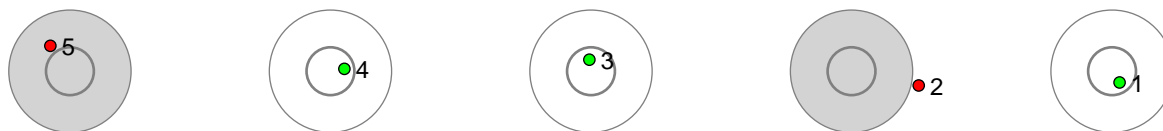

Shooting 2 - Standing at lane 10

5 shots at 8.0s Result: 2

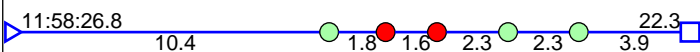
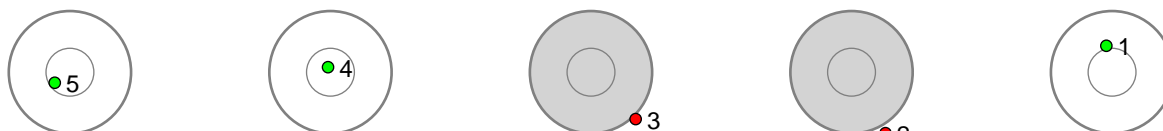

Disclaimer:

These results are unofficial since only the final output from the timing system can provide complete and correct competition results. The graphic plot of each series, presents the location of the shots on each of the five targets. Please observe that the accuracy of the plotting has some limitations due to image resolution and/or printer quality.

224 Sporaland Erik

Figgjo IL

Result: 3

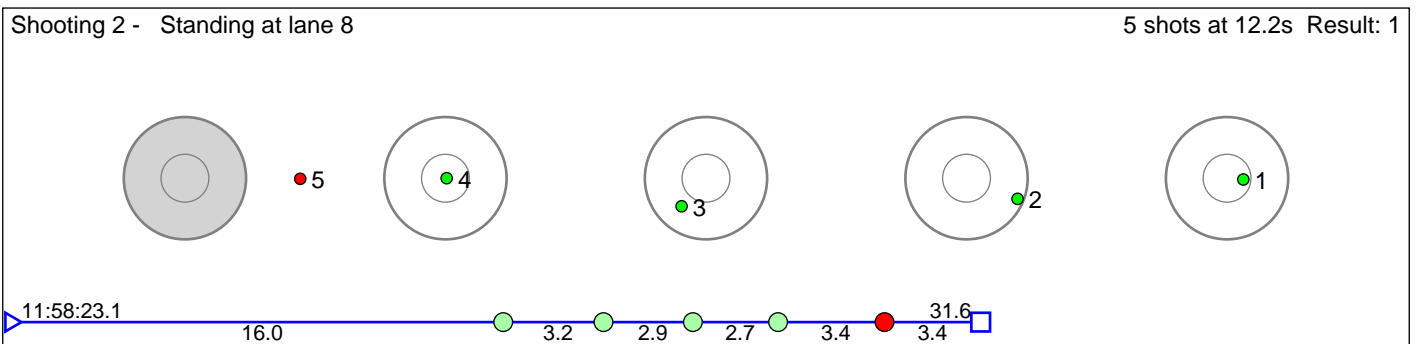
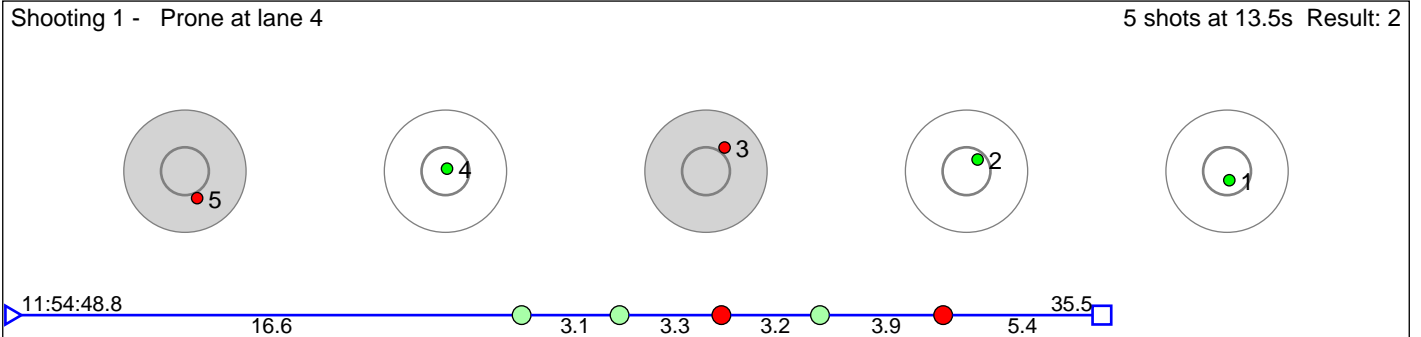

Disclaimer:

These results are unofficial since only the final output from the timing system can provide complete and correct competition results. The graphic plot of each series, presents the location of the shots on each of the five targets. Please observe that the accuracy of the plotting has some limitations due to image resolution and/or printer quality.

226 Tyvold Samuel Stig

Byåsen Skiskytterlag

Result: 4

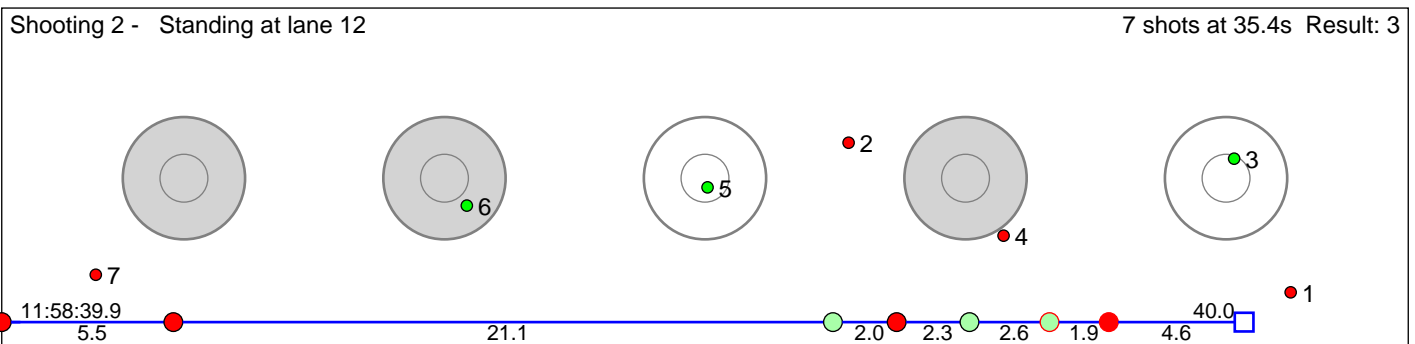
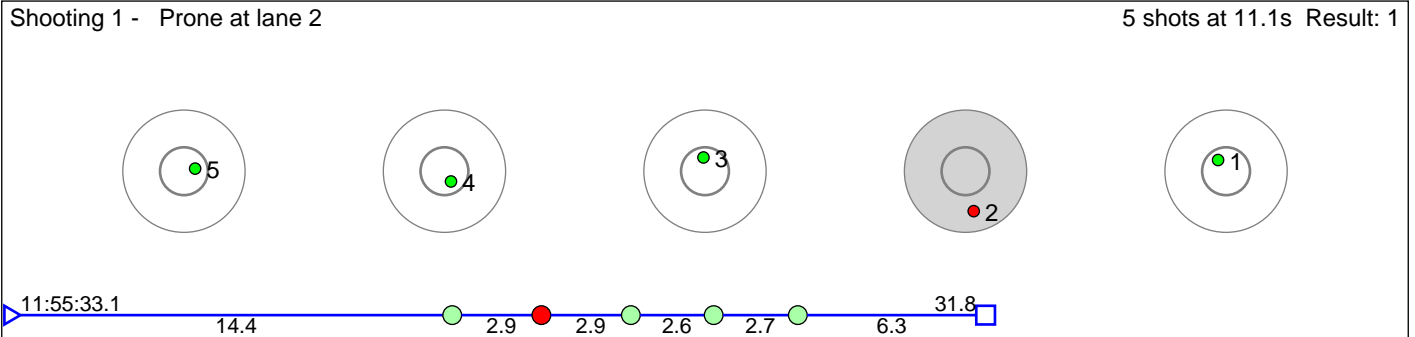

Disclaimer:

These results are unofficial since only the final output from the timing system can provide complete and correct competition results. The graphic plot of each series, presents the location of the shots on each of the five targets. Please observe that the accuracy of the plotting has some limitations due to image resolution and/or printer quality.

227 Mars Christian

Result: 3

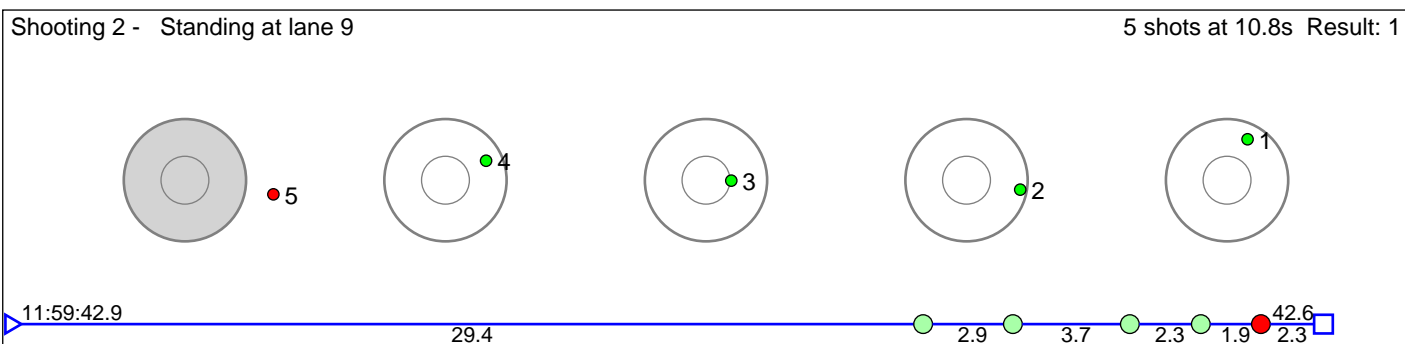
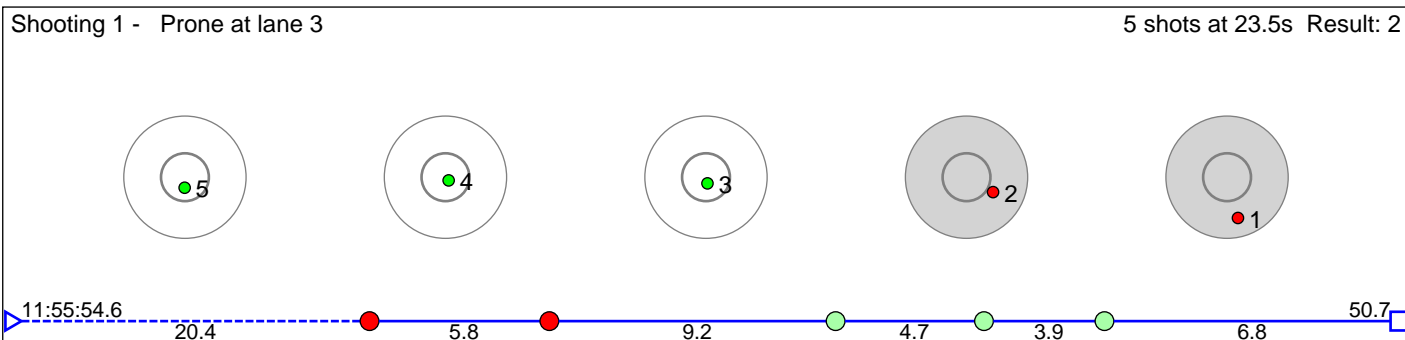

Disclaimer:

These results are unofficial since only the final output from the timing system can provide complete and correct competition results. The graphic plot of each series, presents the location of the shots on each of the five targets. Please observe that the accuracy of the plotting has some limitations due to image resolution and/or printer quality.

229 Aas Andreas

Birkenes IL

Result: 2

Shooting 1 - Prone at lane 1

5 shots at 12.7s Result: 0

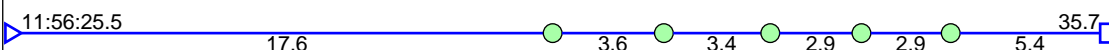
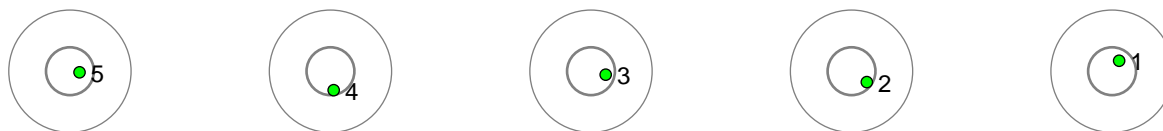

Shooting 2 - Standing at lane 8

5 shots at 10.1s Result: 2

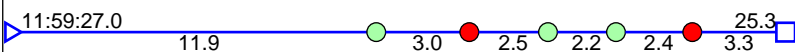
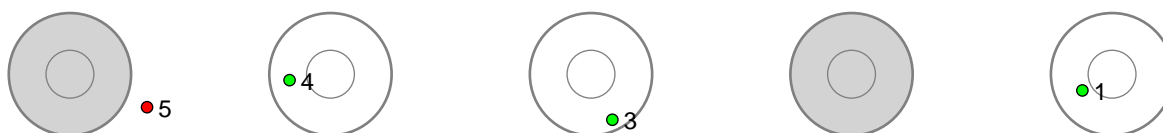

Disclaimer:

These results are unofficial since only the final output from the timing system can provide complete and correct competition results. The graphic plot of each series, presents the location of the shots on each of the five targets. Please observe that the accuracy of the plotting has some limitations due to image resolution and/or printer quality.

230 Suhrke Ole Tafjord

Ivrig IL

Result: 6

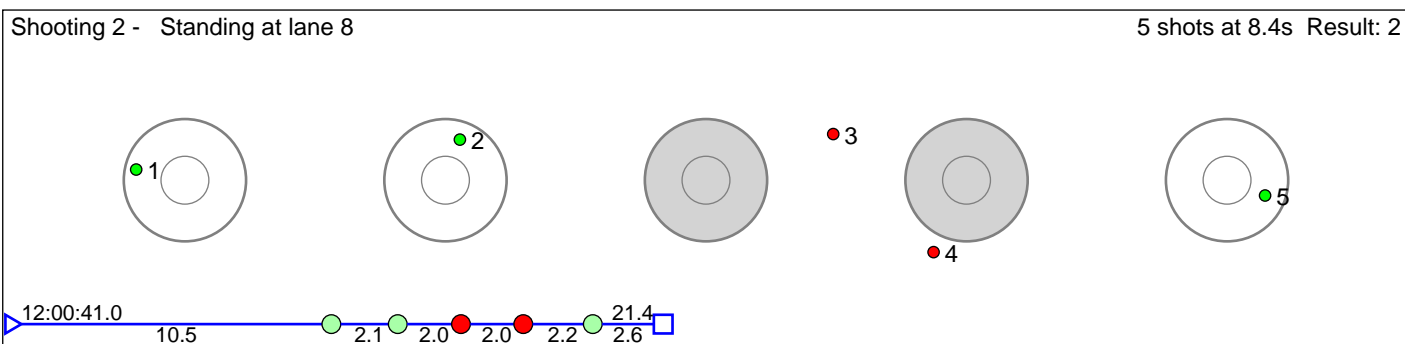
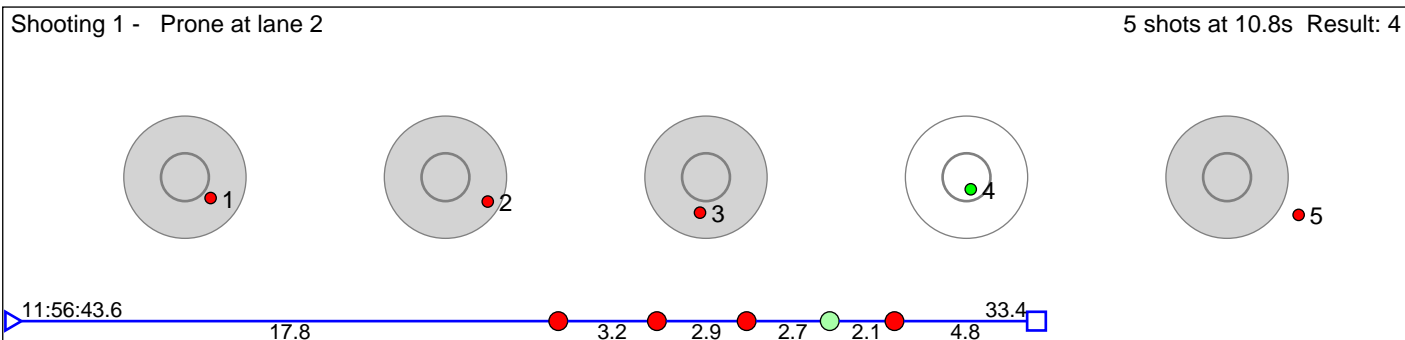

Disclaimer:

These results are unofficial since only the final output from the timing system can provide complete and correct competition results. The graphic plot of each series, presents the location of the shots on each of the five targets. Please observe that the accuracy of the plotting has some limitations due to image resolution and/or printer quality.

231 Willassen Johannes

Oslo Skiskytterlag

Result: 5

Shooting 1 - Prone at lane 3

5 shots at 11.7s Result: 2

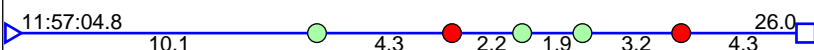
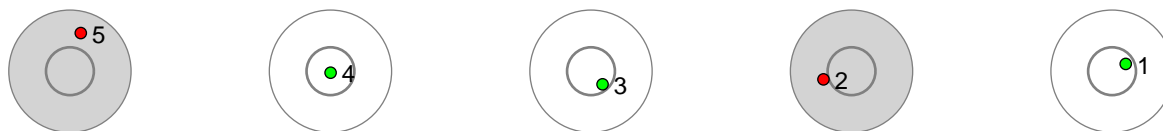

Shooting 2 - Standing at lane 10

5 shots at 9.9s Result: 3

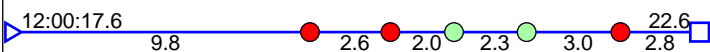
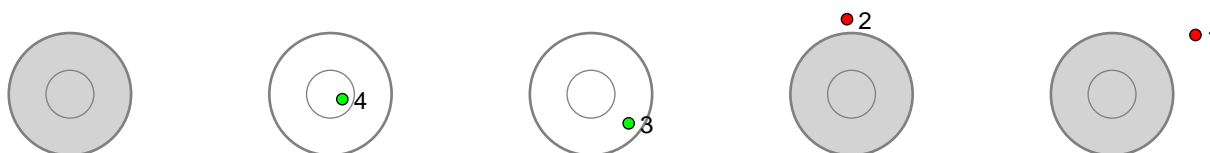

Disclaimer:

These results are unofficial since only the final output from the timing system can provide complete and correct competition results. The graphic plot of each series, presents the location of the shots on each of the five targets. Please observe that the accuracy of the plotting has some limitations due to image resolution and/or printer quality.

232 Stræte Stein Aas

Hønefoss Skiskytterklubb

Result: 6

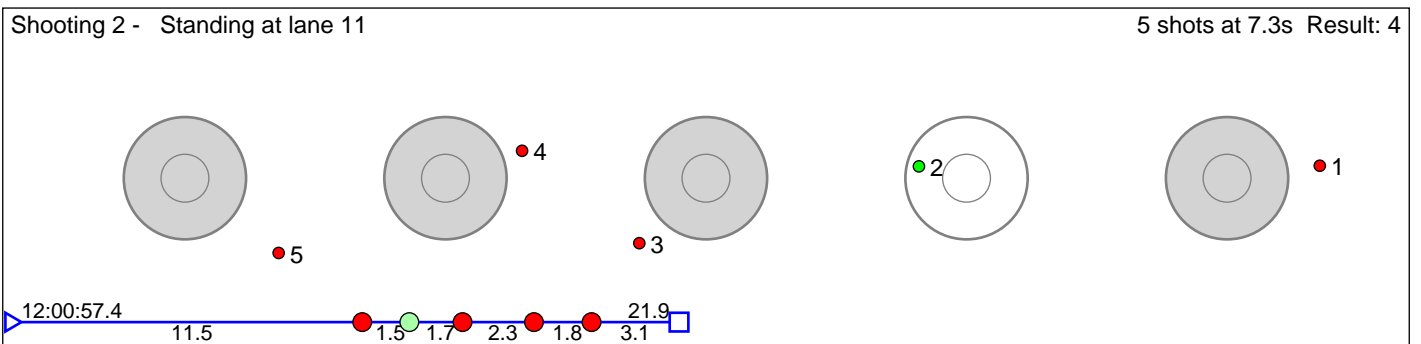
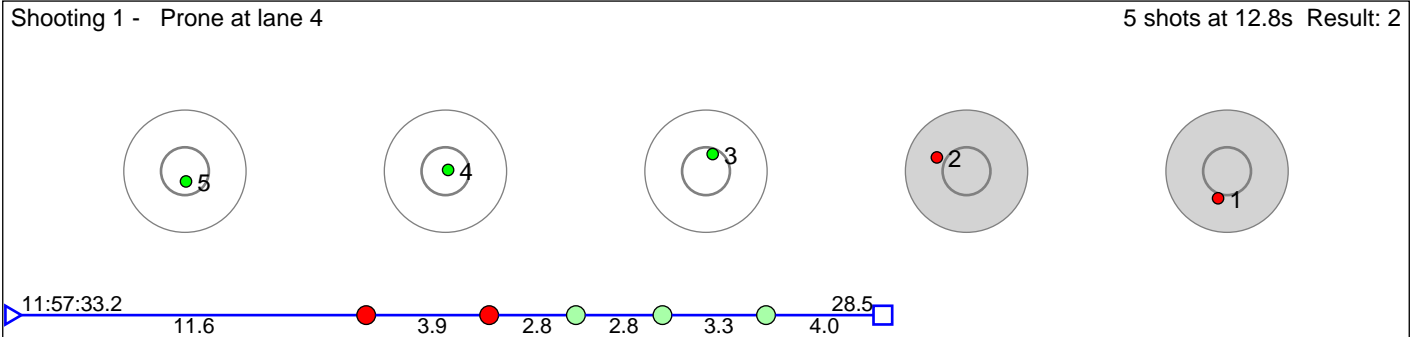

Disclaimer:

These results are unofficial since only the final output from the timing system can provide complete and correct competition results. The graphic plot of each series, presents the location of the shots on each of the five targets. Please observe that the accuracy of the plotting has some limitations due to image resolution and/or printer quality.

233 Hegre Mathias

Sirdal Skilag

Result: 5

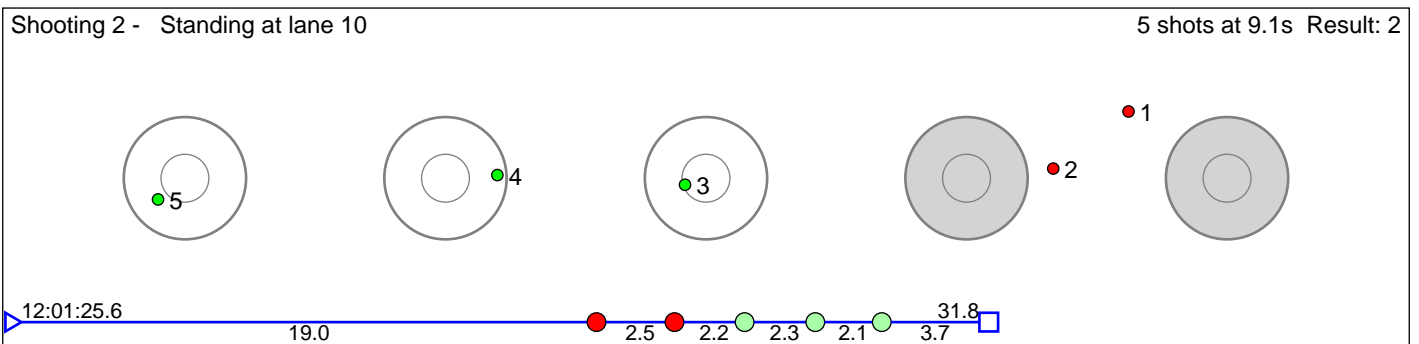
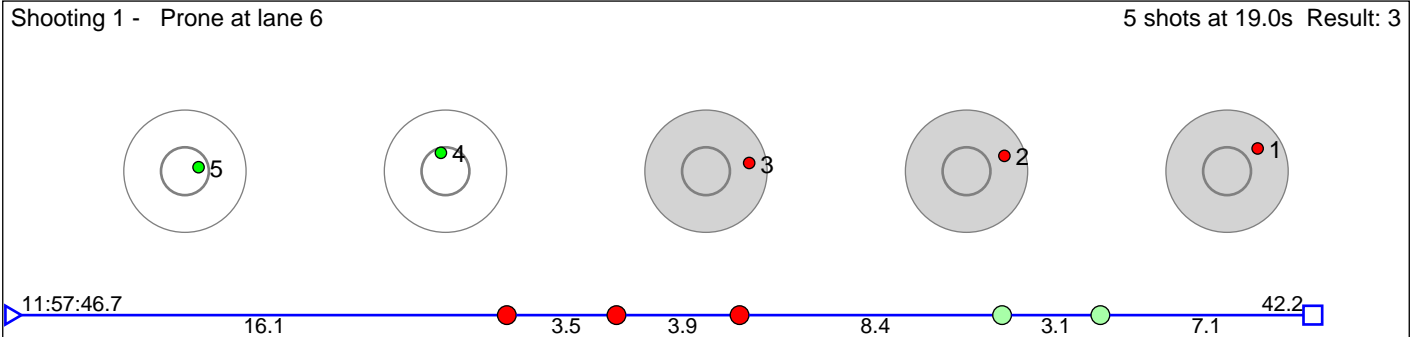

Disclaimer:

These results are unofficial since only the final output from the timing system can provide complete and correct competition results. The graphic plot of each series, presents the location of the shots on each of the five targets. Please observe that the accuracy of the plotting has some limitations due to image resolution and/or printer quality.

234 Tosterud Håvard

Østre Toten Skilag

Result: 3

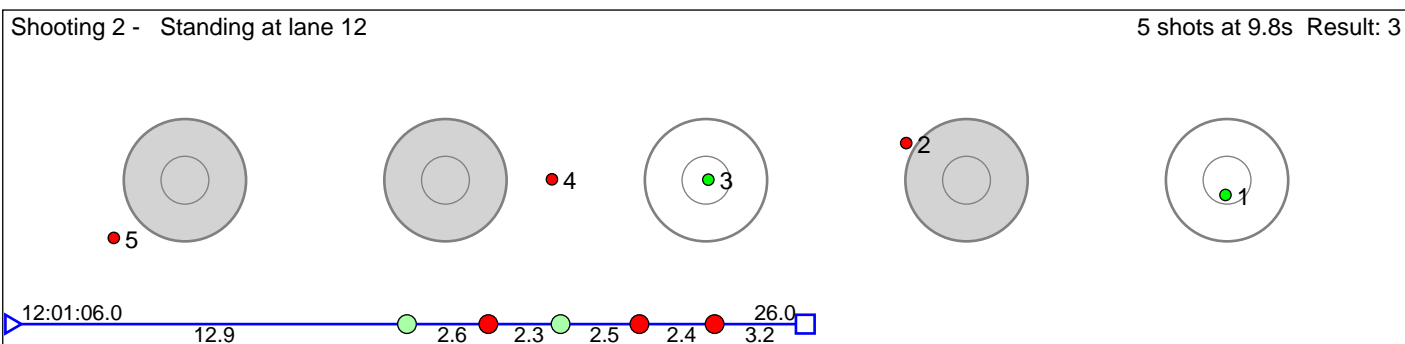
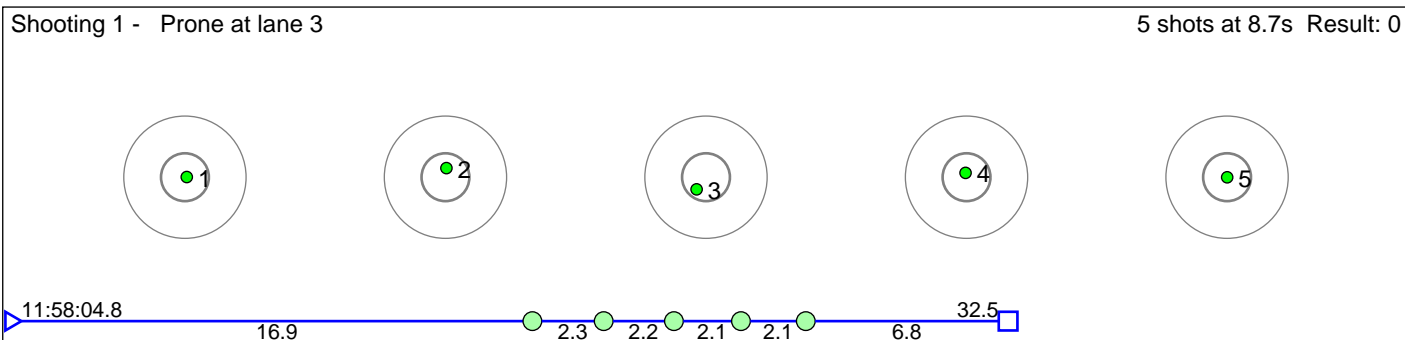

Disclaimer:

These results are unofficial since only the final output from the timing system can provide complete and correct competition results. The graphic plot of each series, presents the location of the shots on each of the five targets. Please observe that the accuracy of the plotting has some limitations due to image resolution and/or printer quality.

235 Wang Ask Grøtan

Fossum IF

Result: 5

Shooting 1 - Prone at lane 4

5 shots at 16.0s Result: 2

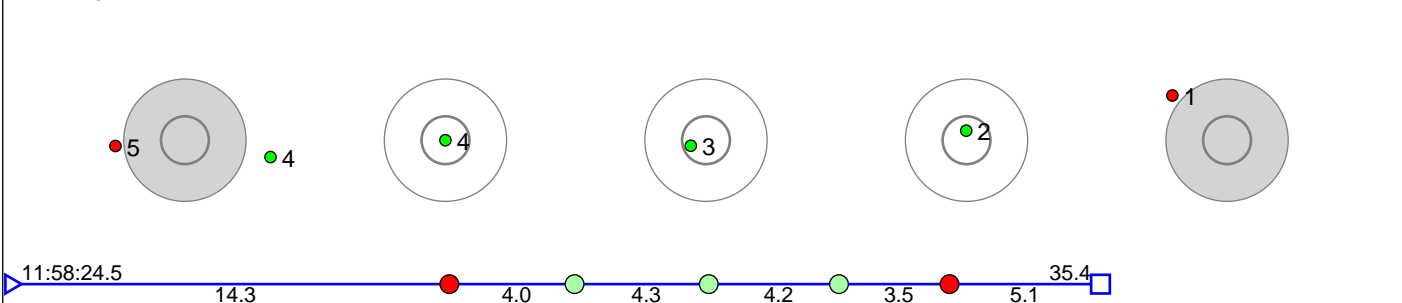

Shooting 2 - Standing at lane 8

5 shots at 15.6s Result: 3

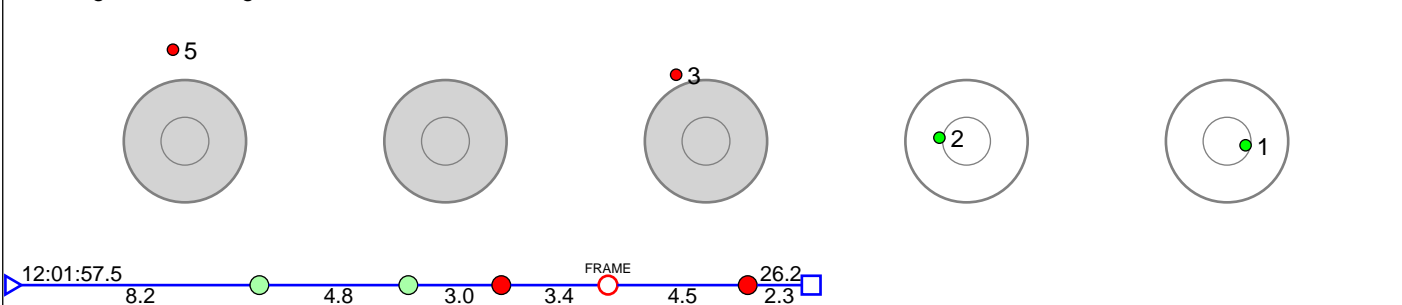

Disclaimer:

These results are unofficial since only the final output from the timing system can provide complete and correct competition results. The graphic plot of each series, presents the location of the shots on each of the five targets. Please observe that the accuracy of the plotting has some limitations due to image resolution and/or printer quality.

236 Nesse Henrik Schioldborg

Try, Idrettslaget

Result: 6

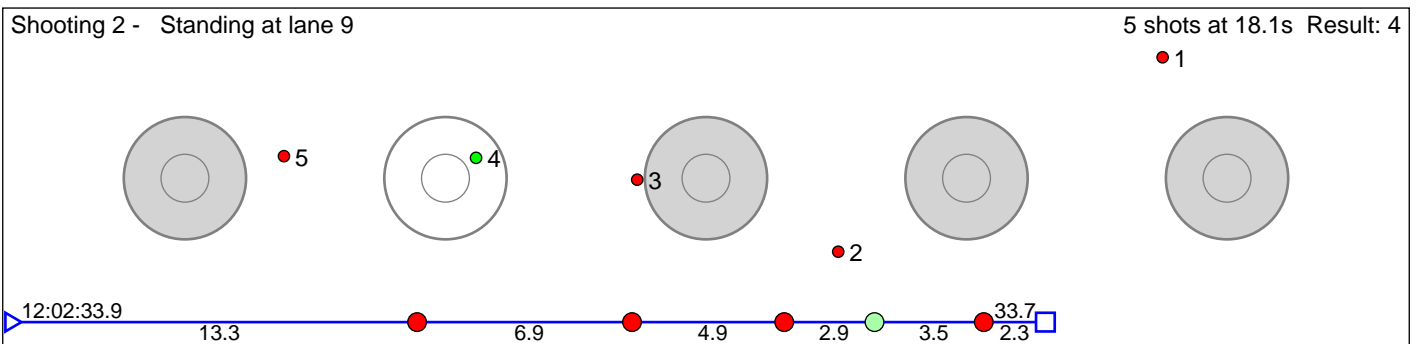
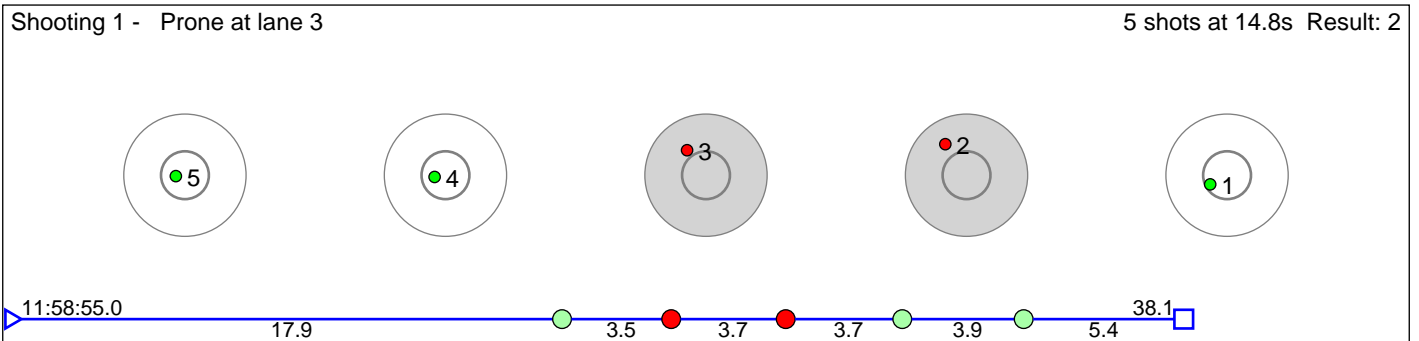

Disclaimer:

These results are unofficial since only the final output from the timing system can provide complete and correct competition results. The graphic plot of each series, presents the location of the shots on each of the five targets. Please observe that the accuracy of the plotting has some limitations due to image resolution and/or printer quality.

237 Bakke Magnus Skeide

Eid IL

Result: 6

Shooting 1 - Prone at lane 5

5 shots at 12.4s Result: 3

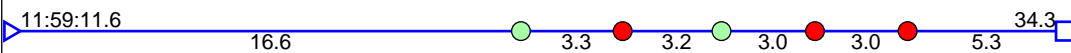
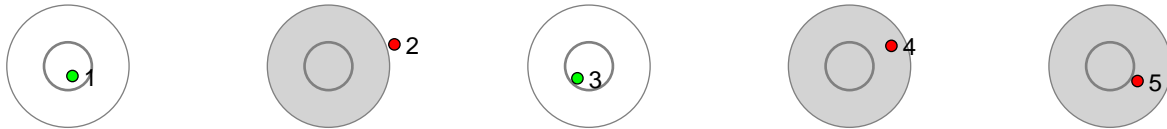

Shooting 2 - Standing at lane 10

5 shots at 12.3s Result: 3

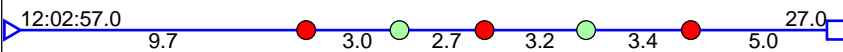
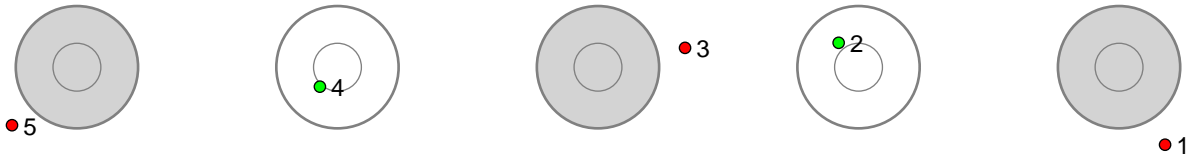

Disclaimer:

These results are unofficial since only the final output from the timing system can provide complete and correct competition results. The graphic plot of each series, presents the location of the shots on each of the five targets. Please observe that the accuracy of the plotting has some limitations due to image resolution and/or printer quality.

238 Runer Fabian von Saldern

Bærums Skiklub

Result: 4

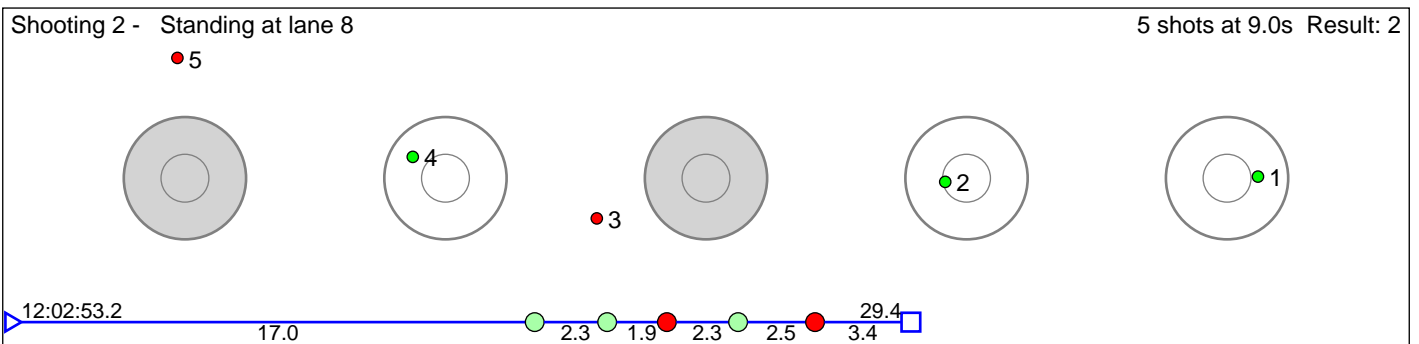
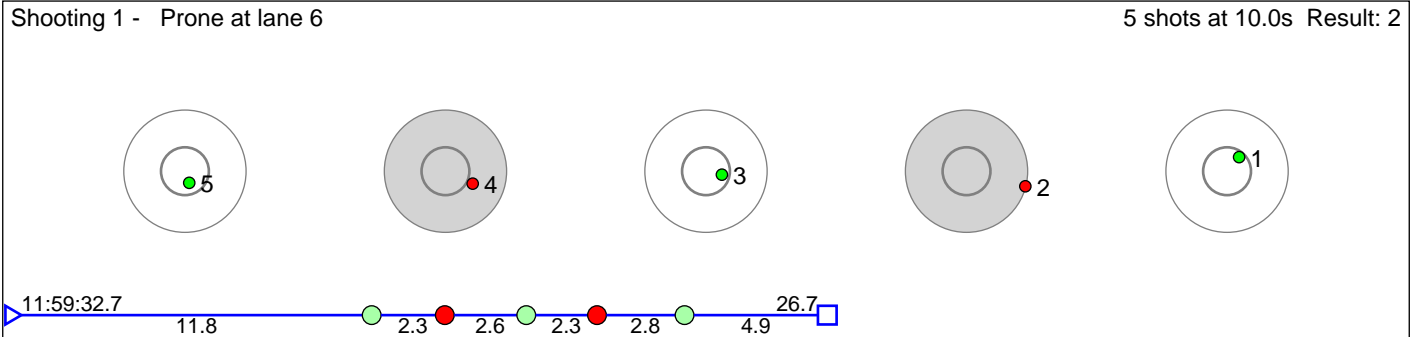

Disclaimer:

These results are unofficial since only the final output from the timing system can provide complete and correct competition results. The graphic plot of each series, presents the location of the shots on each of the five targets. Please observe that the accuracy of the plotting has some limitations due to image resolution and/or printer quality.

240 Kvanli Ole-Kristian

Målselvs Skiskyttere

Result: 3

Shooting 1 - Prone at lane 3

5 shots at 8.7s Result: 2

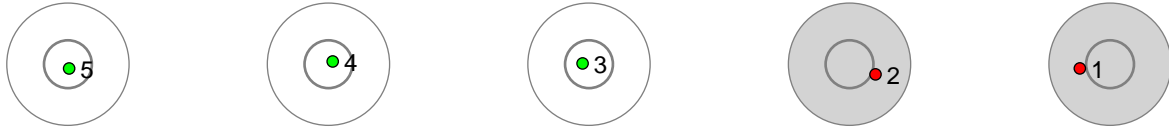

Shooting 2 - Standing at lane 8

5 shots at 7.6s Result: 1

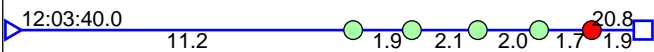
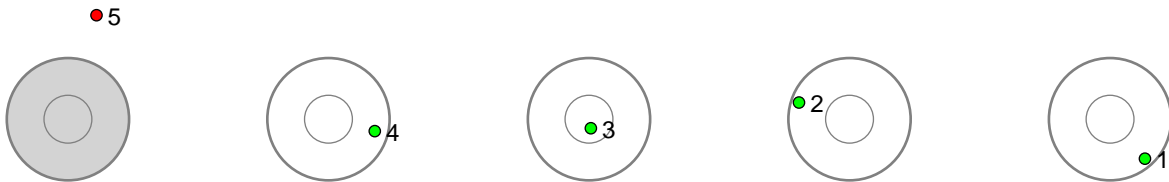

Disclaimer:

These results are unofficial since only the final output from the timing system can provide complete and correct competition results. The graphic plot of each series, presents the location of the shots on each of the five targets. Please observe that the accuracy of the plotting has some limitations due to image resolution and/or printer quality.

243 Hægeland Torkel

Øvrebø IL

Result: 3

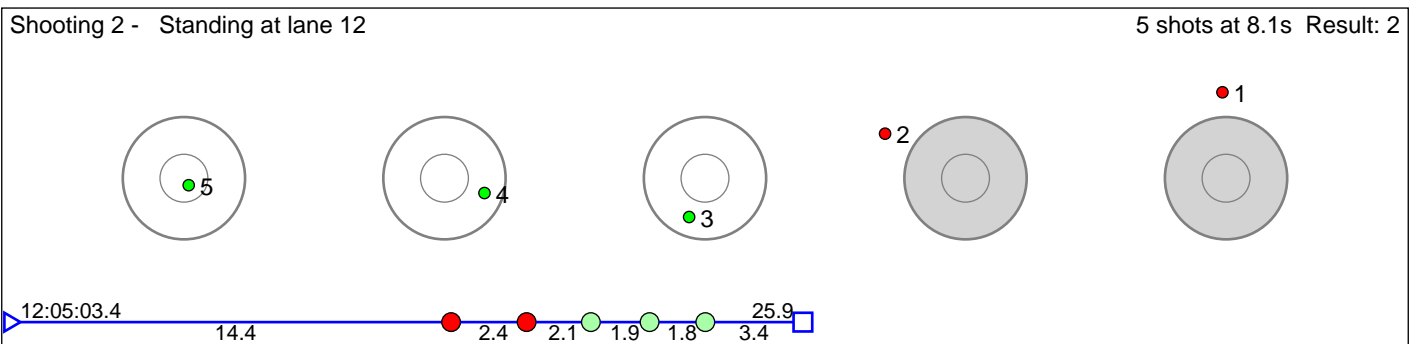
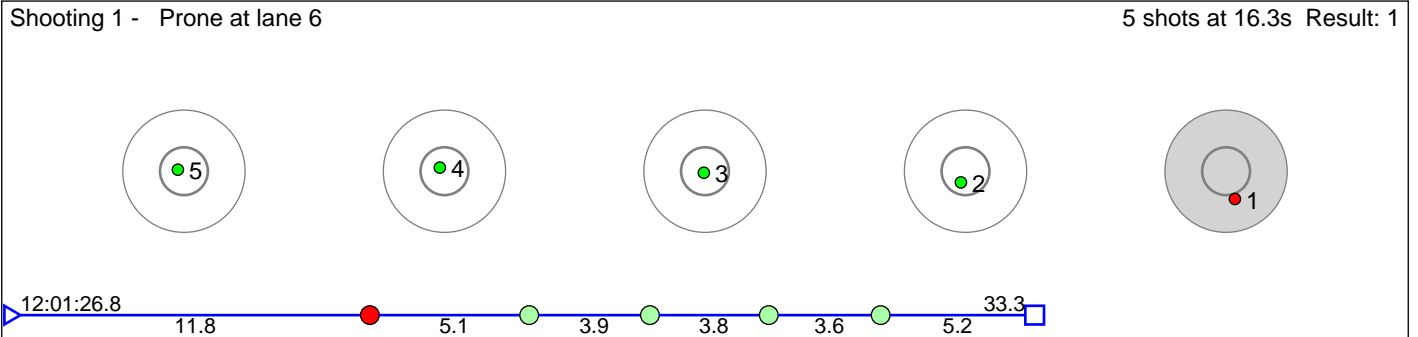

Disclaimer:

These results are unofficial since only the final output from the timing system can provide complete and correct competition results. The graphic plot of each series, presents the location of the shots on each of the five targets. Please observe that the accuracy of the plotting has some limitations due to image resolution and/or printer quality.

244 Røed Normann Sander

Froland IL

Result: 3

Shooting 1 - Prone at lane 7

5 shots at 15.1s Result: 2

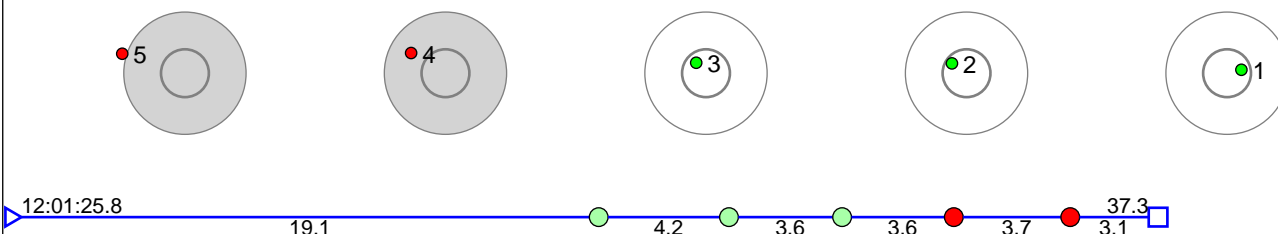

Shooting 2 - Standing at lane 10

5 shots at 12.5s Result: 1

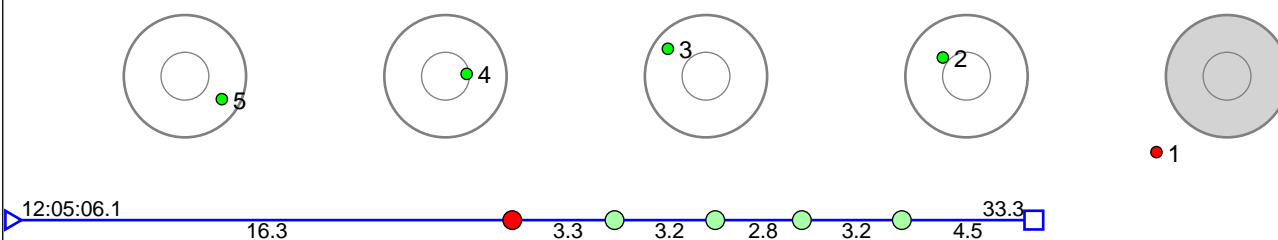

Disclaimer:

These results are unofficial since only the final output from the timing system can provide complete and correct competition results. The graphic plot of each series, presents the location of the shots on each of the five targets. Please observe that the accuracy of the plotting has some limitations due to image resolution and/or printer quality.

245 Mandzyn Vitalii

Result: 3

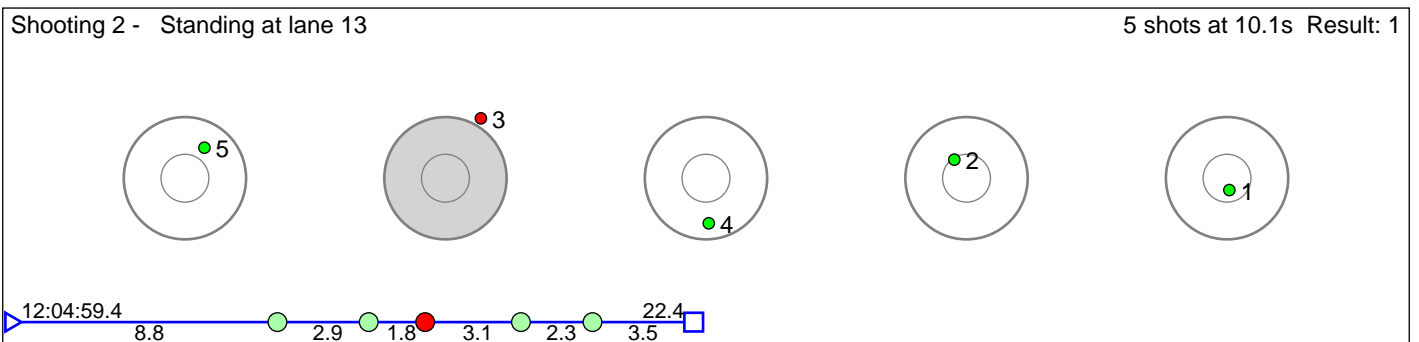
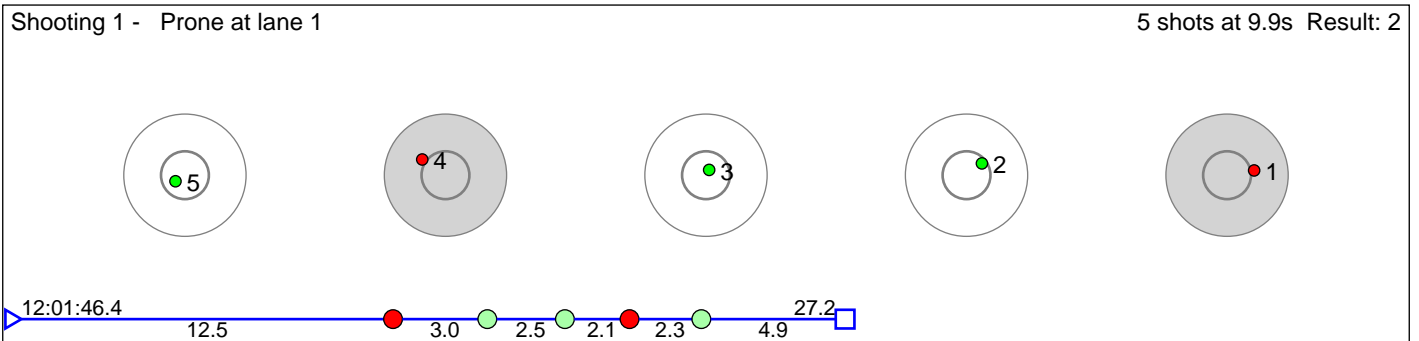

Disclaimer:

These results are unofficial since only the final output from the timing system can provide complete and correct competition results. The graphic plot of each series, presents the location of the shots on each of the five targets. Please observe that the accuracy of the plotting has some limitations due to image resolution and/or printer quality.

246 Furum Casper Jacobsen

Bærums Skiklub

Result: 5

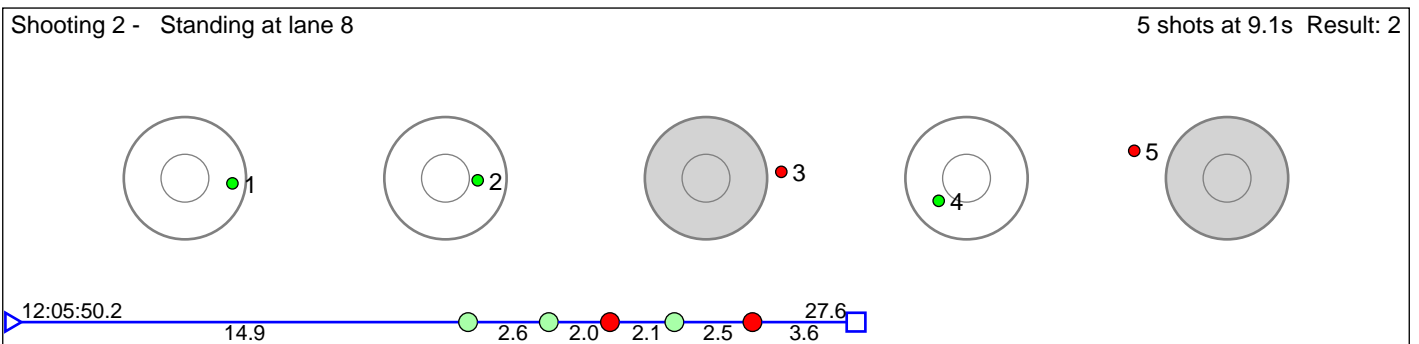
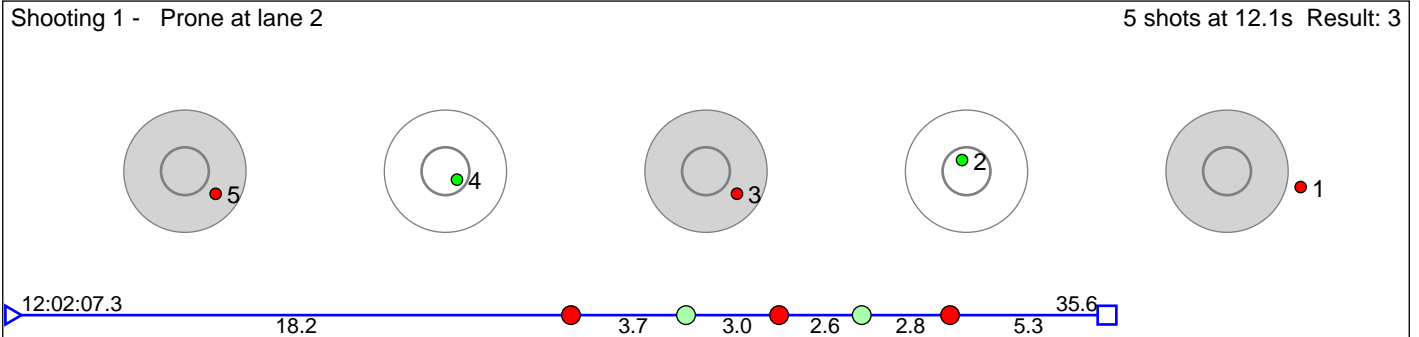

Disclaimer:

These results are unofficial since only the final output from the timing system can provide complete and correct competition results. The graphic plot of each series, presents the location of the shots on each of the five targets. Please observe that the accuracy of the plotting has some limitations due to image resolution and/or printer quality.

247 Wallenius Jakob

Oslo Skiskytterlag

Result: 2

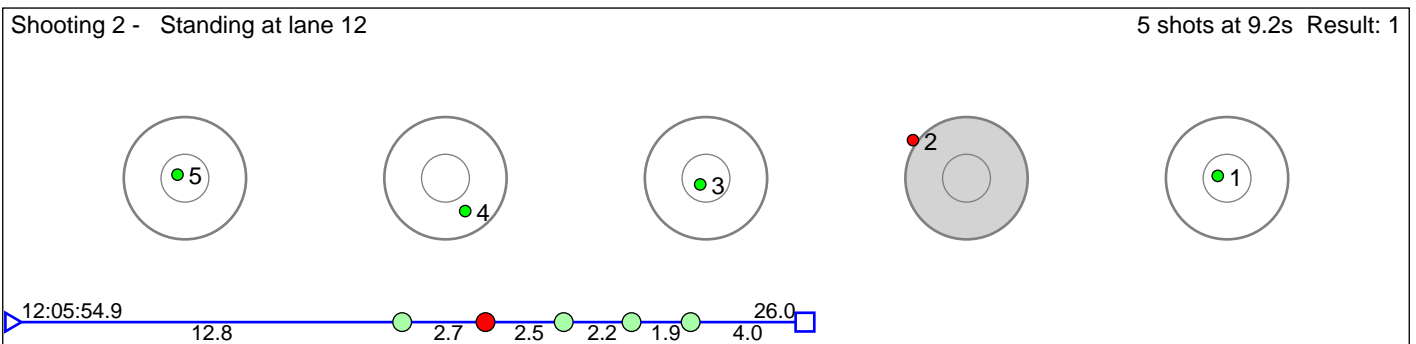
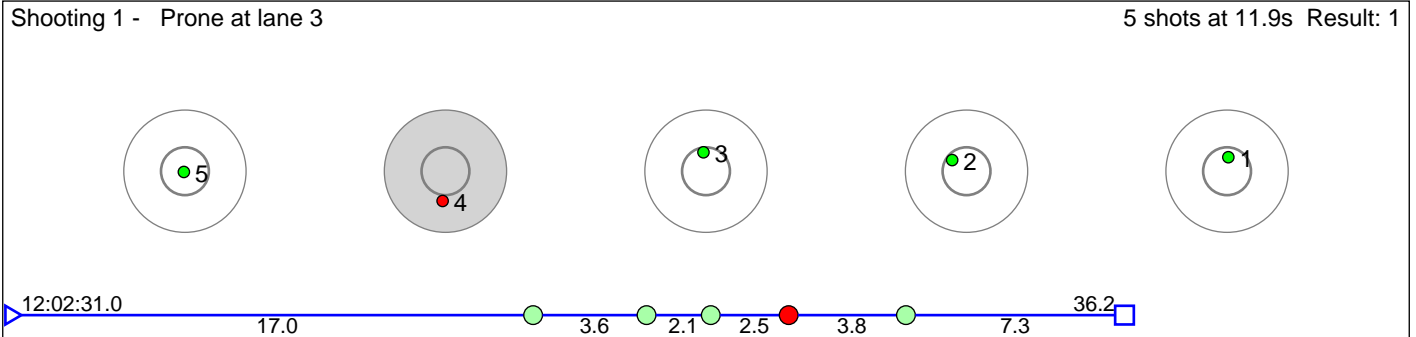

Disclaimer:

These results are unofficial since only the final output from the timing system can provide complete and correct competition results. The graphic plot of each series, presents the location of the shots on each of the five targets. Please observe that the accuracy of the plotting has some limitations due to image resolution and/or printer quality.

248 Berland Vinjar Aurstad

Vingrom IL

Result: 6

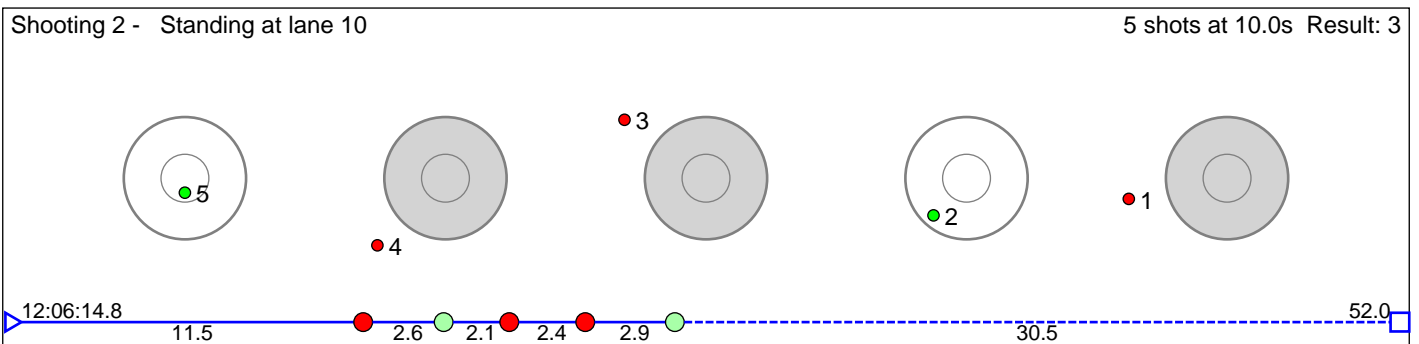
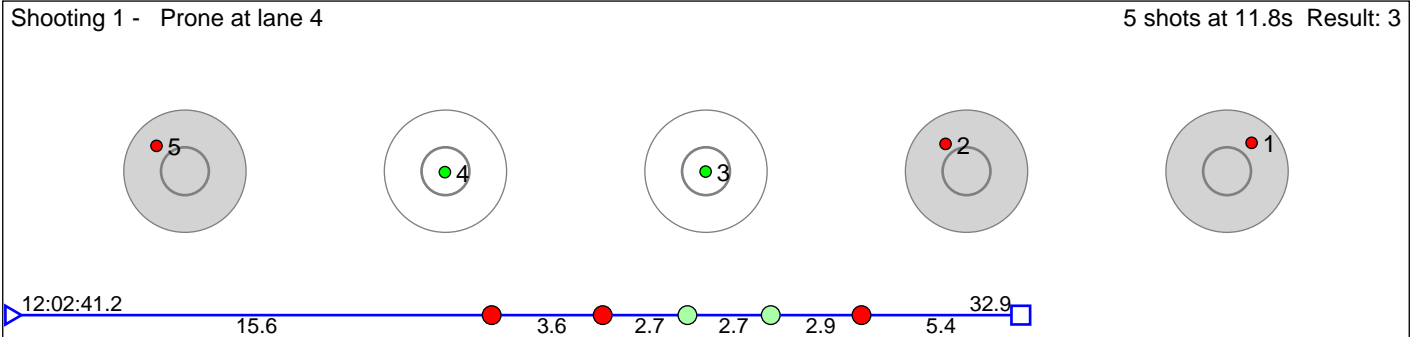

Disclaimer:

These results are unofficial since only the final output from the timing system can provide complete and correct competition results. The graphic plot of each series, presents the location of the shots on each of the five targets. Please observe that the accuracy of the plotting has some limitations due to image resolution and/or printer quality.

249 Frey Isak Leknes

Bærums Skiklub

Result: 2

Shooting 1 - Prone at lane 5

5 shots at 7.7s Result: 1

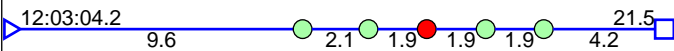
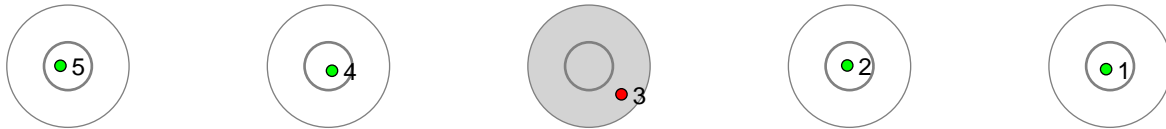

Shooting 2 - Standing at lane 9

5 shots at 6.3s Result: 1

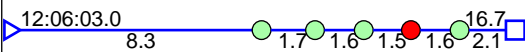
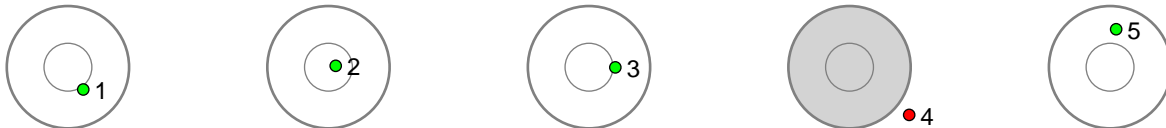

Disclaimer:

These results are unofficial since only the final output from the timing system can provide complete and correct competition results. The graphic plot of each series, presents the location of the shots on each of the five targets. Please observe that the accuracy of the plotting has some limitations due to image resolution and/or printer quality.